

# CARACTERÍSTICAS

MATERIAL Hormigón armado  
 Pino Nórdico FSC®  
 COLOR gris granítico  
 SOPORTES acero zincado pintado  
 al horno color plata  
 ACABADO decapado e hidrofugado  
 COLOC. apoyado sin anclaje  
 PESO 1150 kg / 1175 kg  
 PALET 80X210

MATERIAL Reinforced cast stone  
 Nordic pinewood FSC®  
 COLOUR granite grey  
 SUPPORTS zinquer and coat painted  
 silver steel  
 FINISH acid-etched and waterproofed  
 FIXING free-standing  
 WEIGHT 1150 kg / 1175 kg  
 PALLET 80X210

DISEÑO / DESIGN Iñaki Alday / Margarita Jover

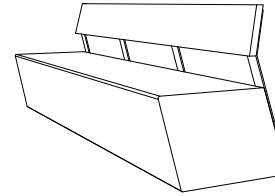

## SISTEMA DE COLOCACIÓN

## GEOMETRÍA

ESCALA 0 CM 50 CM

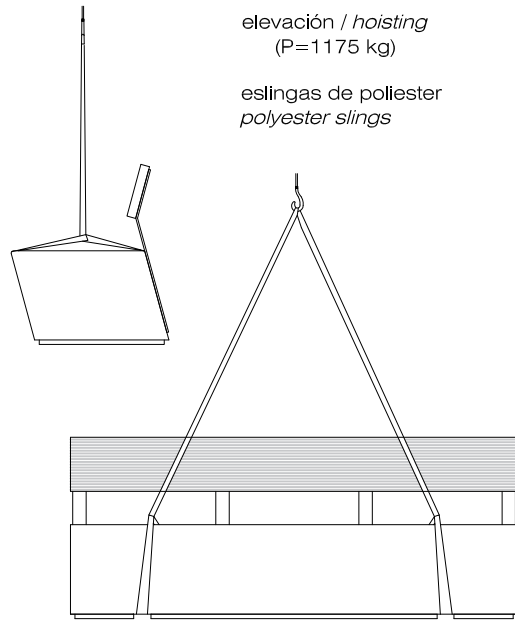

BANCO APOYADO SIN ANCLAJE  
 FREE-STANDING BENCH

EJEMPLOS DE AGREGACIONES

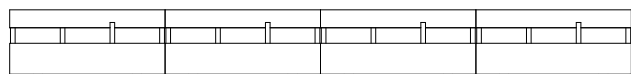

CON RESPALDO  
 WITH BACKREST

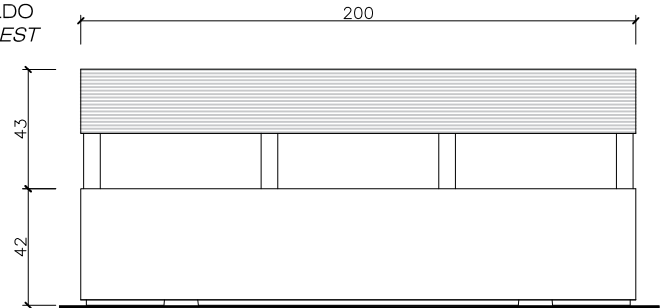

FRONTAL

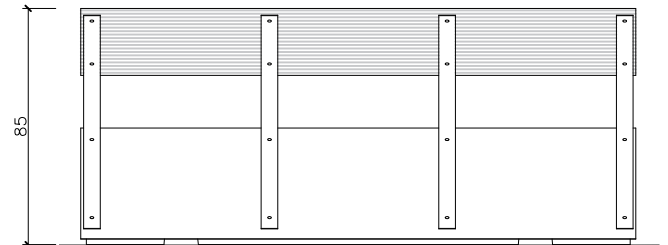

POSTERIOR

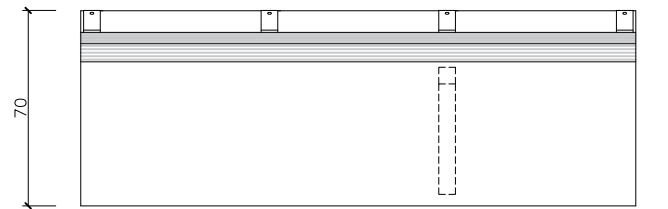

PLANTA

SIN RESPALDO  
 WITHOUT BACKREST

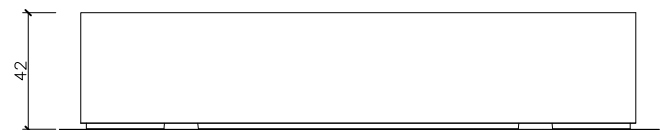

FRONTAL

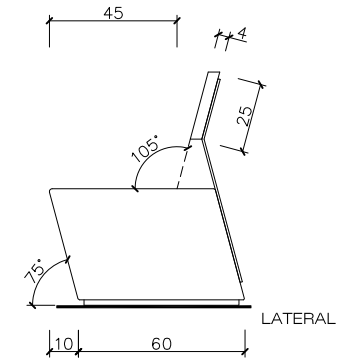

LATERAL

Opcional con o sin reposabrazos  
 Optional with or without armrest

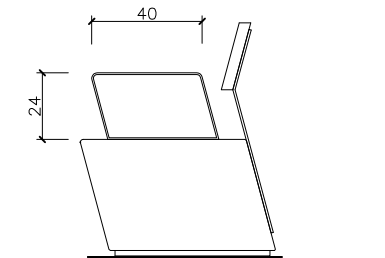

LATERAL

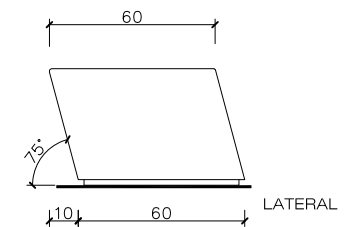

LATERAL