

# CARACTERISTICAS

MATERIAL hormigón UHPC  
 COLOR gris / beige / blanco  
 ACABADO decapado e hidrofugado  
 COLOCACION anclado con tornillos  
 PESO 132 kg / 275 kg  
 537 kg / 596 kg

MATERIAL UHPC concrete  
 COLOUR grey / beige / white  
 FINISH acid-etched and waterproofed  
 FIXING anchored with screws  
 WEIGHT 132 kg / 275 kg  
 537 kg / 596 kg

DISEÑO / DESIGN Equipo Técnico Escofet

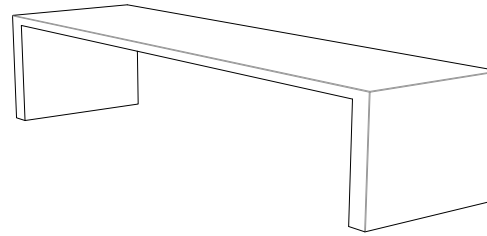

PRIMA 220 / 300 ®

## SISTEMA DE COLOCACION

## GEOMETRIA

ESCALA 0 CM 50 CM

elevación / hoisting  
 (P=537 kg)

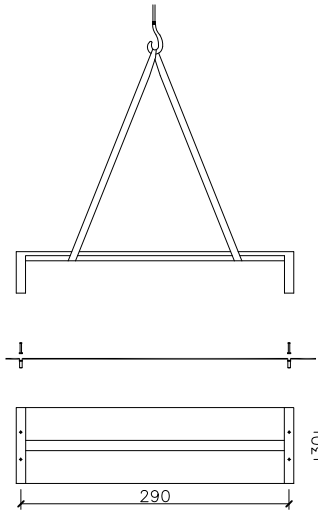

elevación / hoisting  
 (P=275 kg)

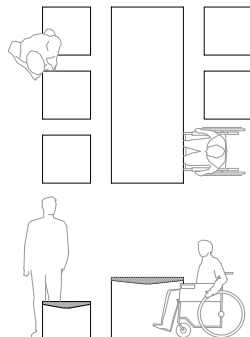
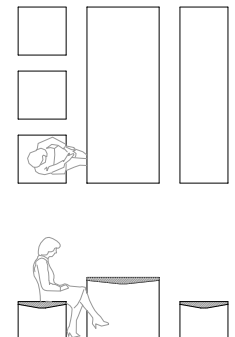
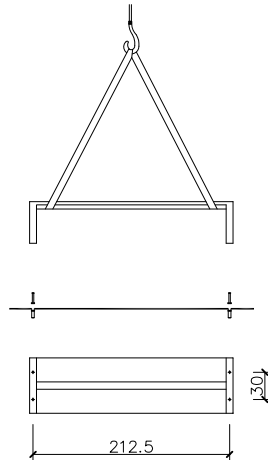

PRIMA 220

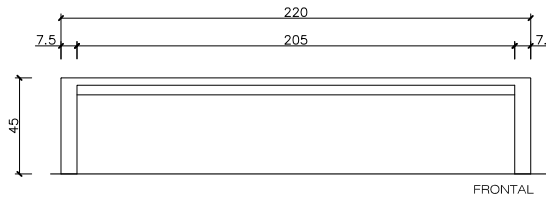

PRIMA BANQUETA

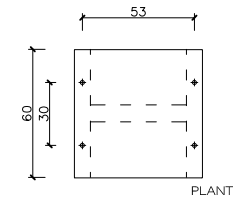
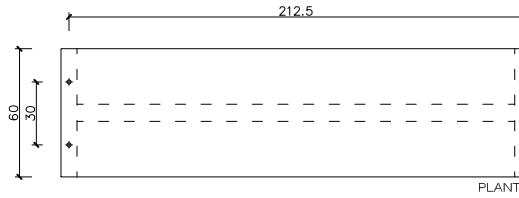
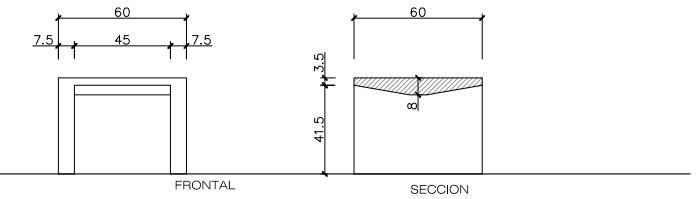

PRIMA 300

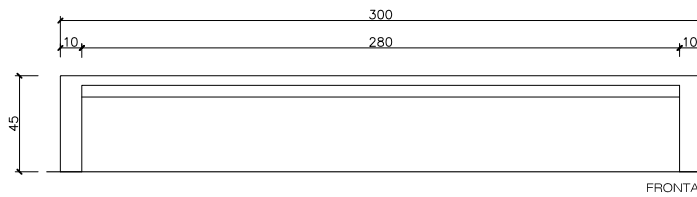

PRIMA MESA

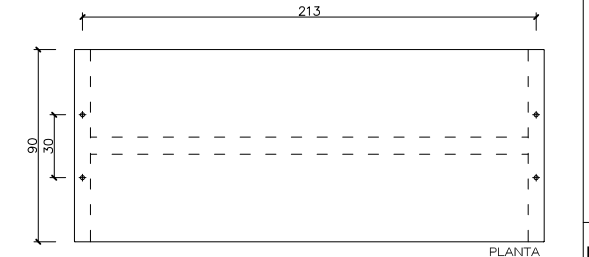
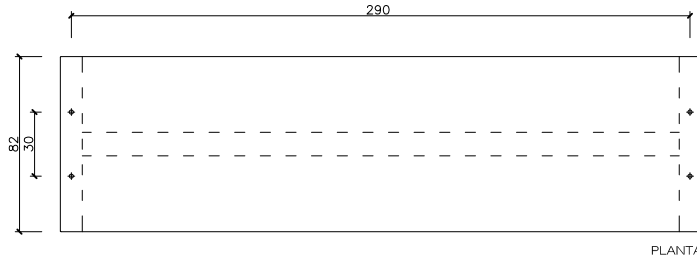
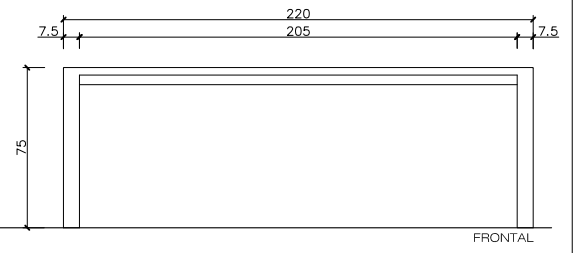

www.escofet.com

escofet

b.36.a