

CARACTERÍSTICAS

MATERIAL	hormigón
COLOR	carta colores estándar
ACABADO	decapado e hidrofugado
RESPALDO y REPOSABRAZOS	acero bricomatado
COLOCACION	ancorado con tornillos
PESO	815 kg / 830 kg / 830 kg / 865 kg
ILUMINACION	Tira Led 12 W/m; 3000°K / 6000°K
DRIVER	24 V / 1,5A / IP67

MATERIAL	cast stone
COLOUR	Standard color chart
FINISH	acid-etched and waterproofed
BACKREST & ARMREST	bricomated steel
FIXING	silver powder coated finish
FIXING	anchored with screws
WEIGHT	815 kg / 830 kg / 830 kg / 865 kg
LIGHTING	Tira Led 12 W/m; 3000°K / 6000°K
DRIVER	24 V / 1,5A / IP67

DISEÑO / DESIGN Vora



SISTEMA DE COLOCACION

elevación / hoisting
(P= 815 kg / 830 kg / 865 kg)

2 eslingas de pollester
2 polyester slings

- Roscar los 2 tornillos a fondo M-16x140
Tightly screw the 2 stud bolts M-16x140

- Taladrar el pavimento (Ø40x180)
y llenar con resina o mortero rico

- Drill pavement (Ø40x180) and
fill with resin or fat mortar

- Centrar y colocar
Centre and caulk

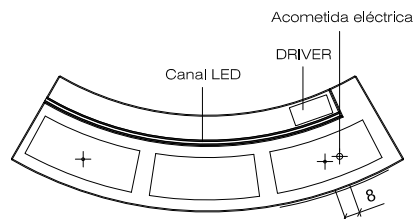
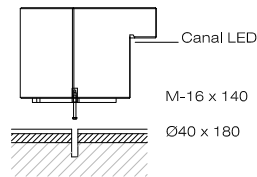
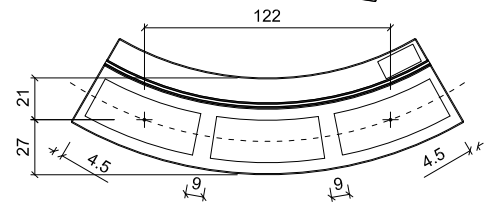
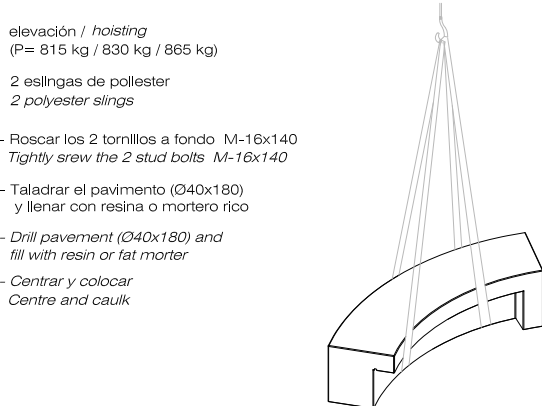

GEOMETRIA

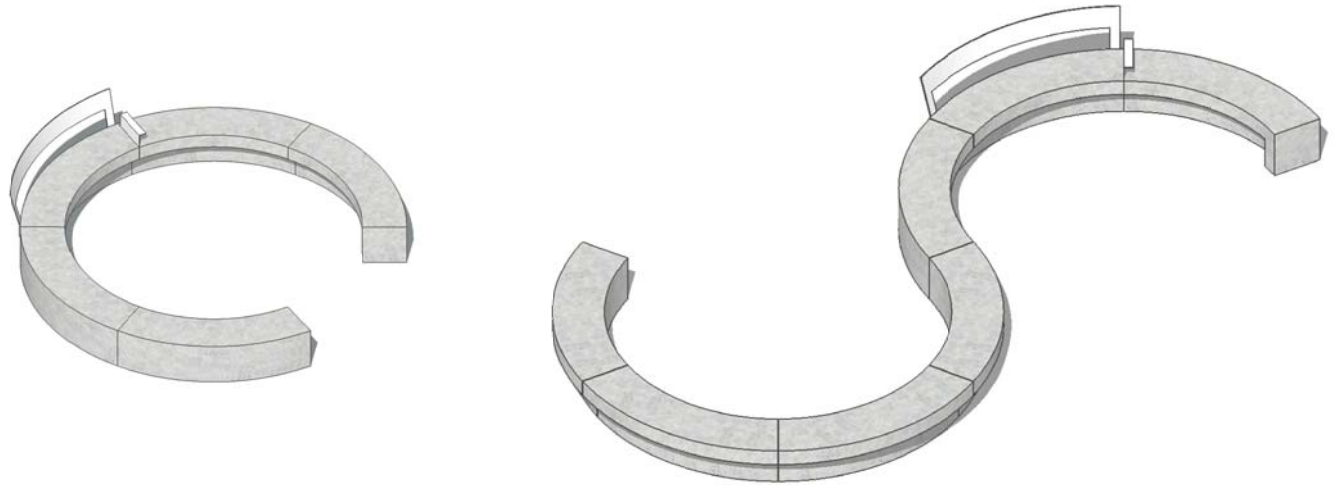

EJEMPLOS DE AGREGACIONES

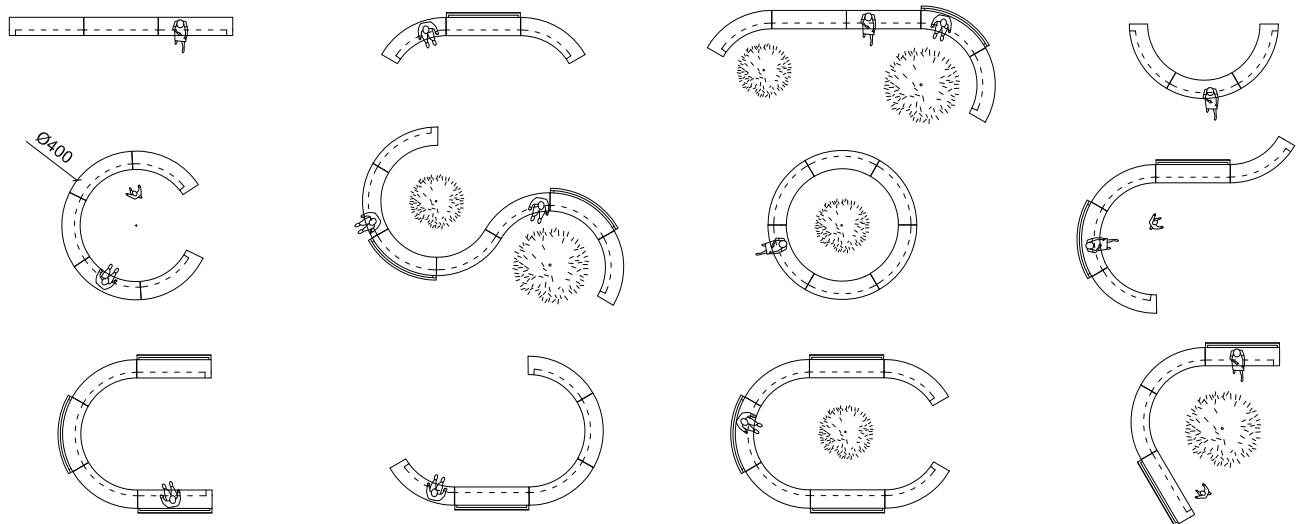

BANCA COMÚ CONCAVO

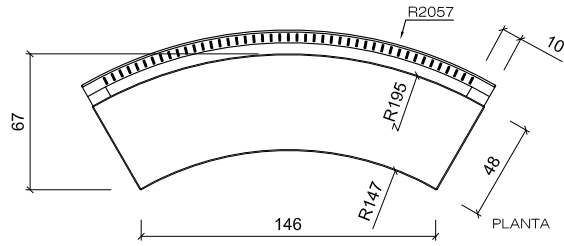

BANCA COMÚ CONVEXO

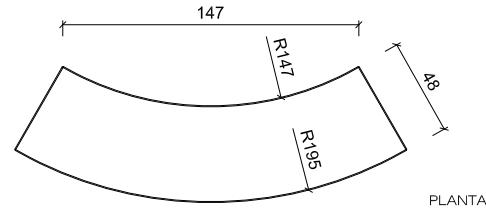

BANCA COMÚ RECTO

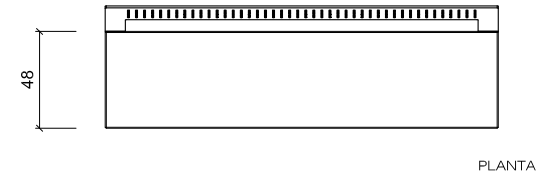

*Respaldo concavo opcional
Optional concave backrest

*Respaldo recto opcional
Optional straight backrest

BANCA C CONCAVO DERECHA
195

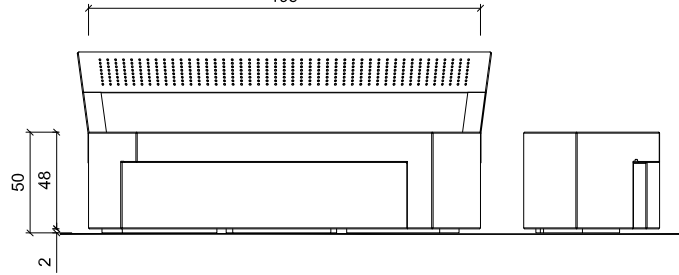

BANCA C CONVEXO DERECHA

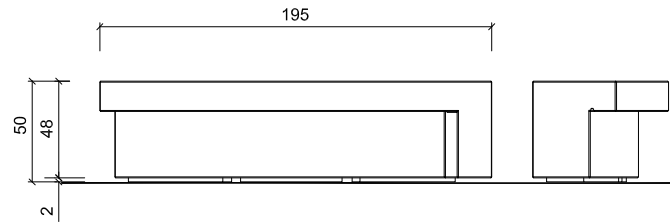

BANCA C RECTO DERECHA / IZQUIERDA / INDIVIDUAL
195

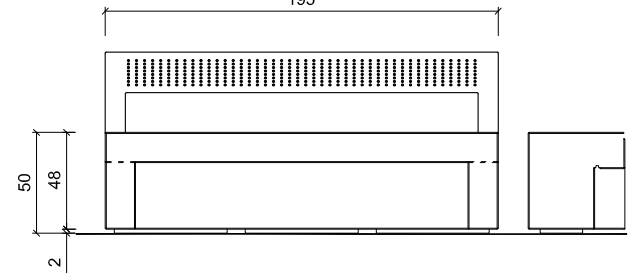

BANCA C CONCAVO CENTRAL
195

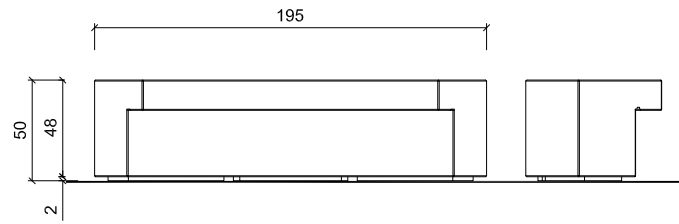

BANCA C CONVEXO CENTRAL
195

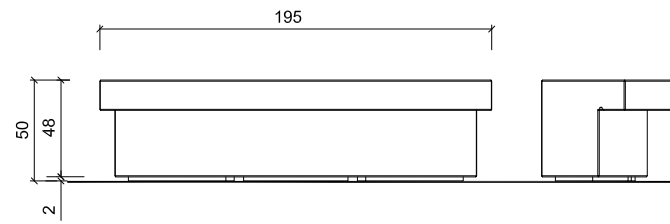

BANCA C RECTO CENTRAL
195

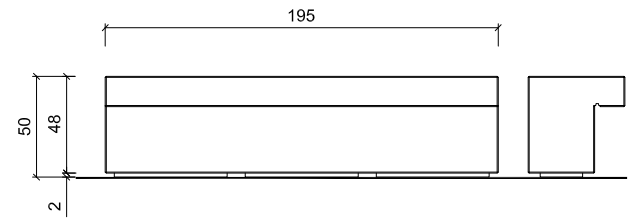

BANCA C CONCAVO IZQUIERDA
195

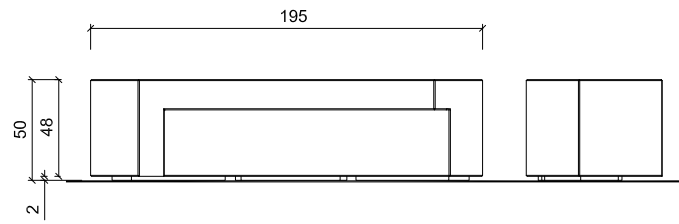

BANCA C CONVEXO IZQUIERDA
195

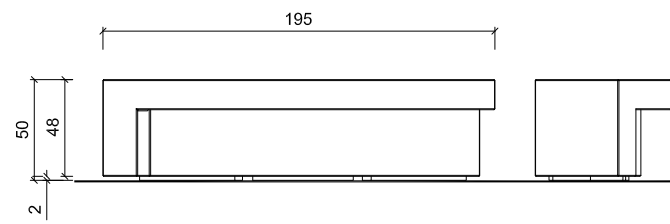

BANCA C CONCAVO INDIVIDUAL
195

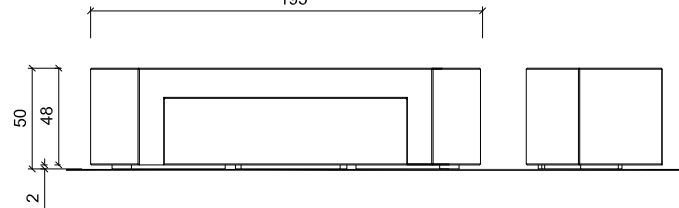

BANCA C CONVEXO INDIVIDUAL
195

