

**CARACTERÍSTICAS / CHARACTERISTICS**

**MATERIAL** madera tropical certificada FSC®  
**ACABADO** tratado con aceite translúcido  
**SOPORTES** acero zincado pintado al horno color plata  
**COLOC.** anclado con tacos de expansión  
**PESO** banco 32,5kg / silla 19,5kg  
 banca 28kg / asiento 16kg

**MATERIAL** tropical wood FSC® certified  
**FINISH** treated with translucent oil  
**SUPPORTS** zinqued and powder coated steel in silver  
**FIXING** anchored with expansion bolts  
**WEIGHT** bench 32,5kg / chair 19,5kg  
 backless bench 28kg / seat 16kg

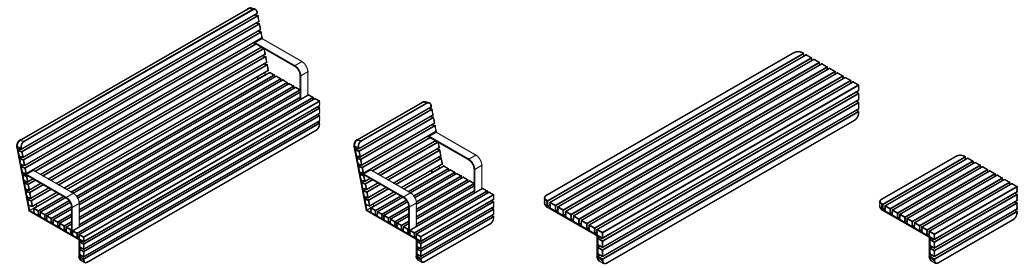

Update 30/10/2018  
 Cotas / Sizes cm

**INSTALACIÓN / INSTALLATION**

Centrar y colocar el accesorio sobre el banco o muro y marcar agujeros colisos  
*Center and place the accessory on the bench or retaining wall and mark the slotted holes*

E:1/20

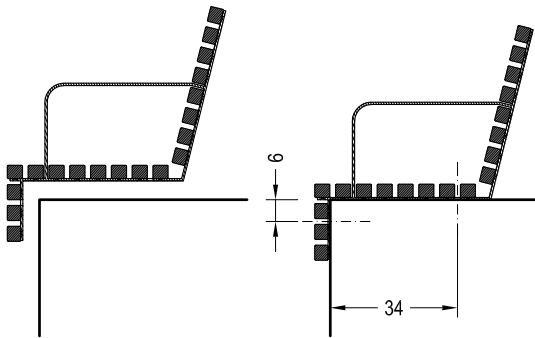

Taladrar el banco o muro y situar el accesorio  
*Drill bench or retaining wall and place the accessory*

E:1/40

Insertar y roscar los 4 o 6 tacos de expansión 8 x 45mm  
*Insert and tightly 4 or 6 expansion bolts 8 x 45mm*

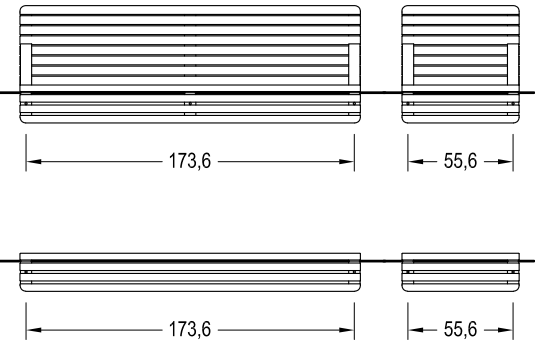

**GEOMETRÍA / GEOMETRY**

**A. UNIVERSE banco / bench**

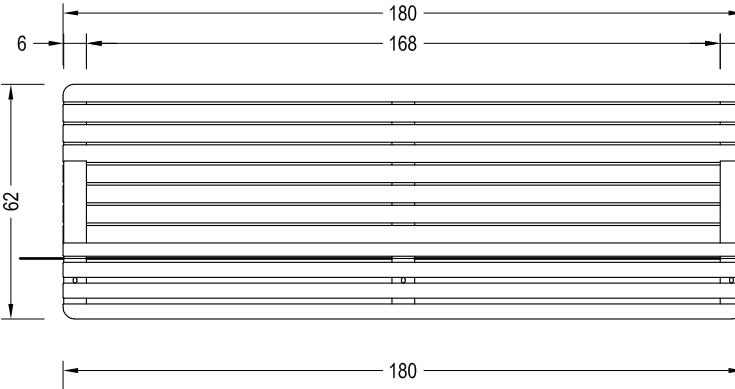

**B. UNIVERSE silla / chair**

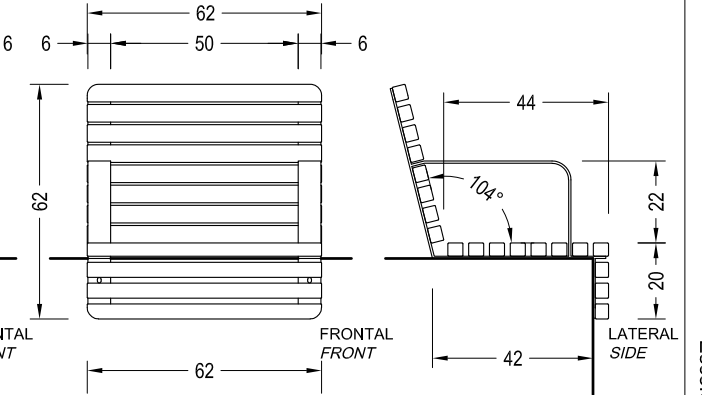

E:1/20

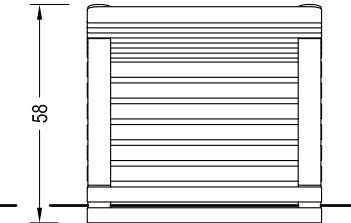
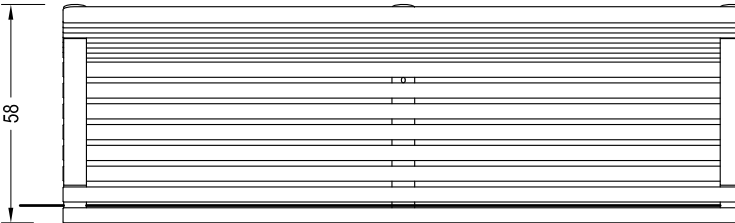

**C. UNIVERSE banca / backless bench**

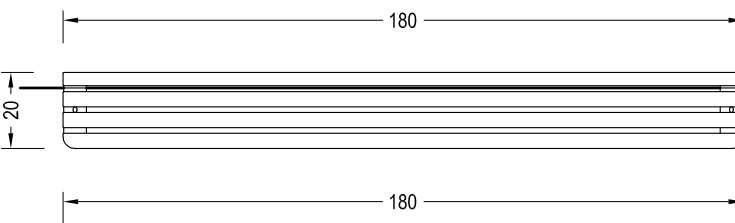

**D. UNIVERSE asiento / seat**

