

# CARACTERÍSTICAS / CHARACTERISTICS

**MATERIAL** hormigón  
**COLOR** carta de colores estándar  
**ACABADO** decapado e hidrofugado  
**ASIENTO** madera tropical certificada FSC®  
 tratada con lasur  
**COLOC.** simplemente apoyado  
**PESO** 1140 kg / 812 kg

**MATERIAL** concrete  
**COLOUR** standard color chart  
**FINISH** etched and waterproofed  
**SEAT** tropical wood FSC® certified  
 treated with lasur  
**FIXING** free-standing element  
**WEIGHT** 1140 kg / 812 kg

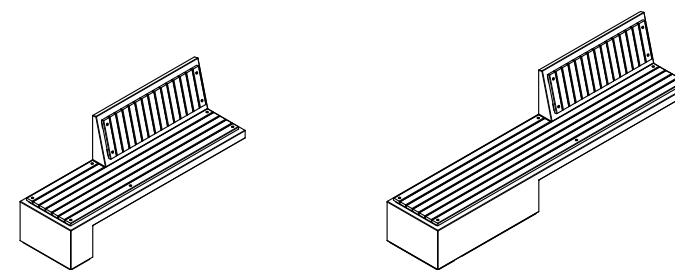

Update 27/11/2018  
 Cotas / Sizes cm

## INSTALACIÓN / INSTALLATION

elevación / hoisting  
 (P = 1140 kg)

E:1/50

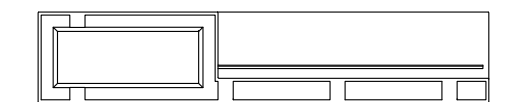
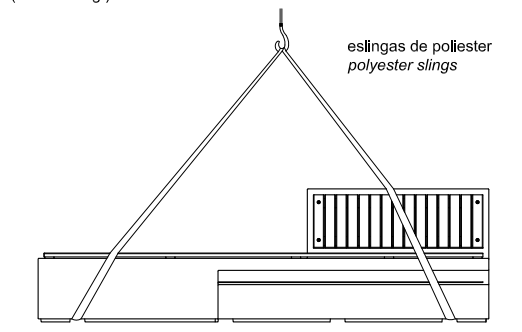

10 | 236 | 10

Banco apoyado sin andaje  
 Free-standing element

elevación / hoisting  
 (P = 812 kg)

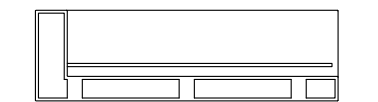
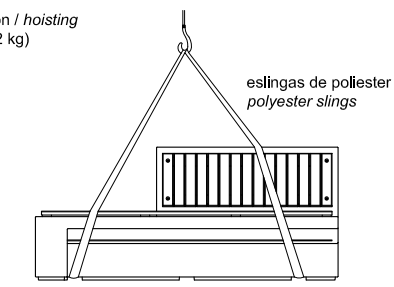

10 | 138 | 10

Banco apoyado sin andaje  
 Free-standing element

## GEOMETRÍA / GEOMETRY

E:1/40

### EQUAL 300

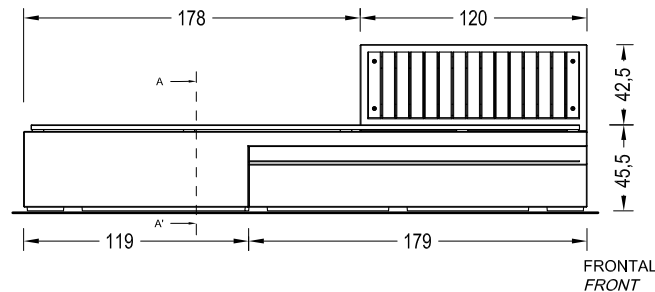

FRONTAL  
 FRONT



PLANTA  
 TOP

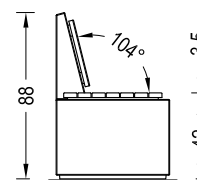

LATERAL  
 SIDE

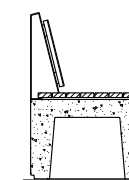

SECCIÓN A-A'  
 SECTION A-A'

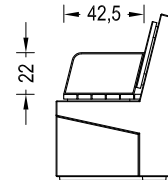

LATERAL  
 SIDE

Con opción apoyabrazos /  
 Optional with armrest

### EQUAL 200

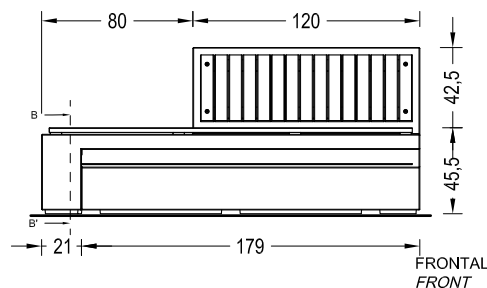

FRONTAL  
 FRONT

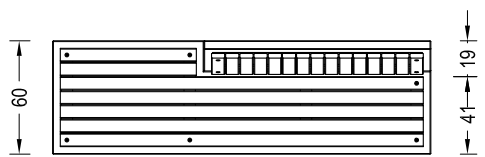

PLANTA  
 TOP

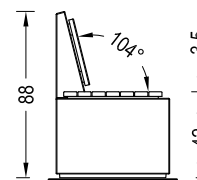

LATERAL  
 SIDE

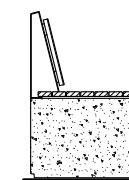

SECCIÓN B-B'  
 SECTION B-B'

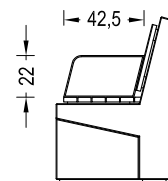

LATERAL  
 SIDE

Con opción apoyabrazos /  
 Optional with armrest

# CARACTERÍSTICAS / CHARACTERISTICS

**MATERIAL** hormigón  
**COLOR** carta de colores estándar  
**ACABADO** decapado e hidrofugado  
**ASIENTO** madera tropical certificada FSC®  
 tratada con lasur  
**COLOC.** simplemente apoyado  
**PESO** 1140 kg / 812 kg

**MATERIAL** concrete  
**COLOUR** standard color chart  
**FINISH** etched and waterproofed  
**SEAT** tropical wood FSC® certified  
 treated with lasur  
**FIXING** free-standing element  
**WEIGHT** 1140 kg / 812 kg

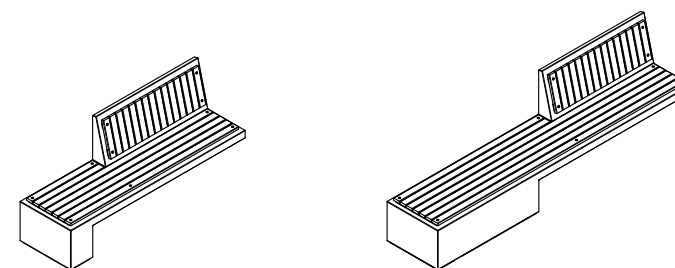

Update 27/11/2018  
 Cotas / Sizes cm

## INSTALACIÓN / INSTALLATION

## GEOMETRÍA / GEOMETRY

E:1/50

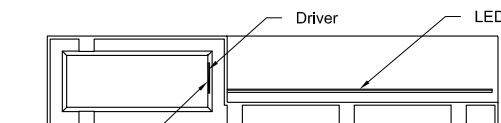

Alimentación  
 Power supply

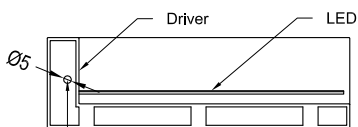

Alimentación  
 Power supply

VISTA INFERIOR PARA REGISTRO  
 ELECTRICAL BOX BOTTOM VIEW

LED	
Tensión de trabajo <i>Operating voltage</i>	24V
Potencia <i>Power</i>	8W/m
Temperatura de color <i>Color temperature</i>	6000K
Grado de protección <i>Degree of protection</i>	IP67

Driver Vossloh o similar <i>Driver Vossloh or similar</i>	
Potencia <i>Power</i>	30W
Voltage <i>Voltage</i>	220-240V
Frecuencia <i>Frequency</i>	50-60Hz
Factor de potencia <i>Power factor</i>	>0,9
Grado de protección <i>Degree of protection</i>	IP67

E:1/40

### EQUAL 300 LED

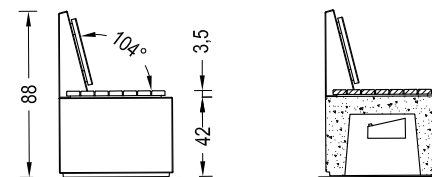
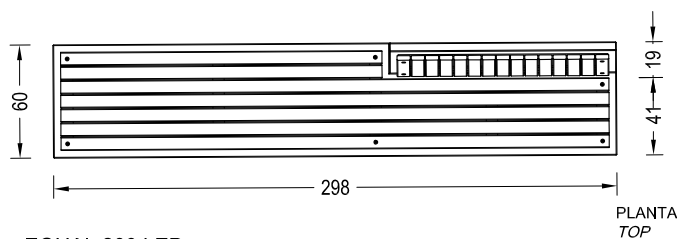
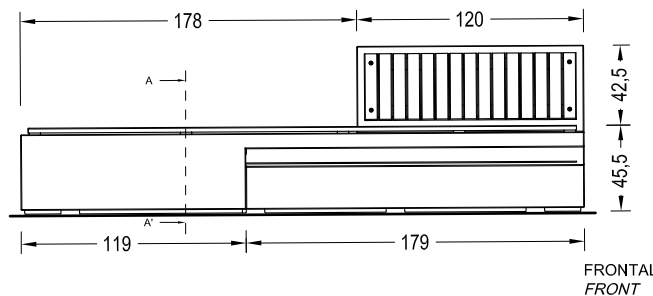

SECCIÓN A-A'  
 SECTION A-A'

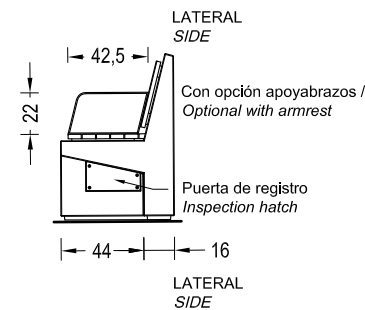

### EQUAL 200 LED

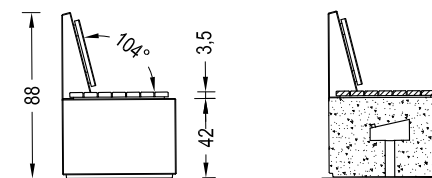
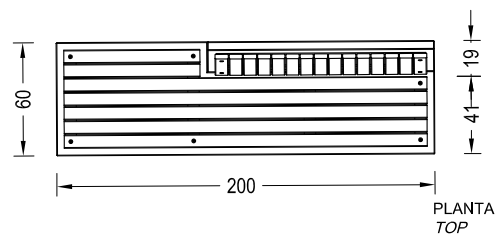
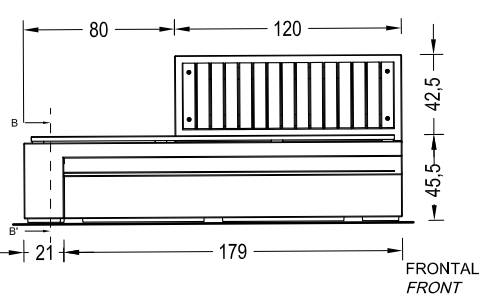

SECCIÓN B-B'  
 SECTION B-B'

