

# CARACTERÍSTICAS / CHARACTERISTICS

**MATERIAL** hormigón / hormigón reciclado  
**COLOR** carta de colores estándar  
**ACABADO** decapado e hidrofugado  
**SOPORTES** acero inox AISI 316L  
**ASIENTO** madera pino certificada FSC®  
 tratado al autoclave y protección fungicida  
 madera tropical certificada FSC®  
 tratado con aceite translúcido  
**COLOC.** anclado con tornillos  
**PESO** sop. banco 95kg / sop. banca 86kg

**MATERIAL** concrete / recycled concrete  
**COLOUR** standard color chart  
**FINISH** etched and waterproofed  
**SUPPORTS** stainless steel AISI 316L  
**SEAT** pine wood FSC® certified  
 pressure treated and preventive fungicide  
 tropical wood FSC® certified  
 treated with translucent oil  
**FIXING** anchored with screws  
**WEIGHT** sup. bench 95kg / sup. backless bench 86kg

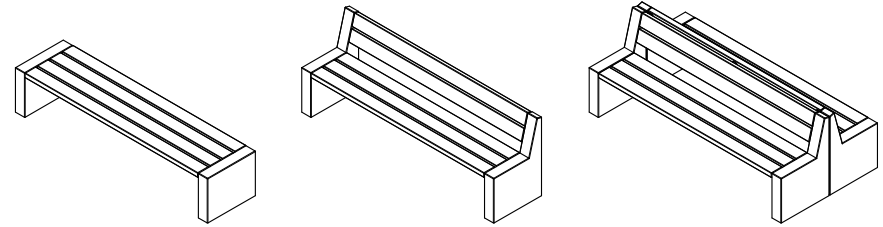

Update 26/10/2018  
 Cotas / Sizes cm

## INSTALACIÓN / INSTALLATION

**ADVERTENCIA.** No es manipulable una vez armado  
**WARNING.** It is not manipulable once armed

Situar los ángulos en los marcos reservados y roscar los tornillos (DIN 7991 M10 x 16mm)  
 Place the angles in the reserved frames and tightly screws (DIN 7991M10 x 16mm)

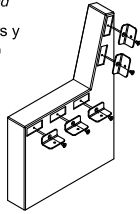

Roscar 2 tornillos a fondo (DIN 931 M16 x 140mm)  
 Taladrar el pavimento y llenar de resina o mortero rico  
 Tightly screw 2 stud bolts (DIN 931 M16 x 140mm)  
 Drill pavement fill with resin or fat mortar

elevación / hoisting  
 (P = banco 95 kg / banca 86 kg)

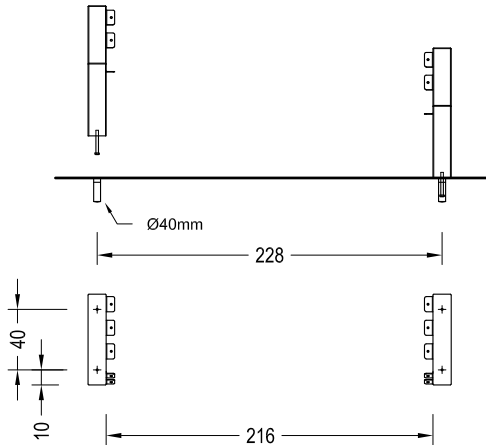

Centrar y colocar el conjunto de listones sobre los soportes.  
 Roscar los tornillos (DIN 7360 M8 x 10mm)  
 Center and place the set of boards on the bench.  
 Tightly screws (DIN 7360M8 x 10mm)

elevación / hoisting  
 (P = banco 25 kg - 35 kg / banca 46 kg)

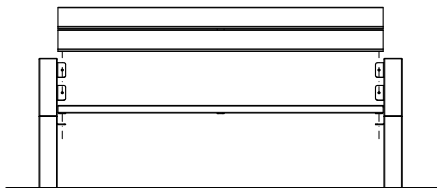

## GEOMETRÍA / GEOMETRY

ALPINE Banca

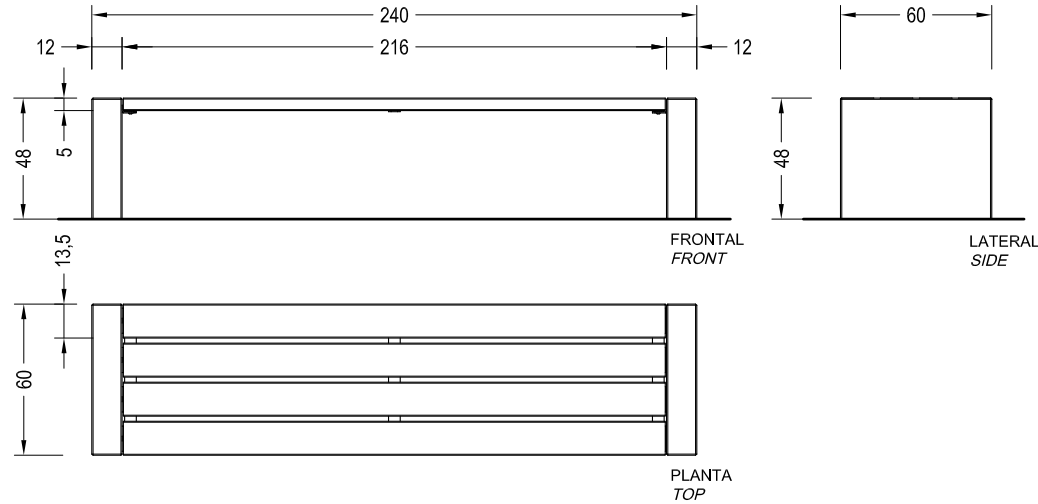

ALPINE Banco

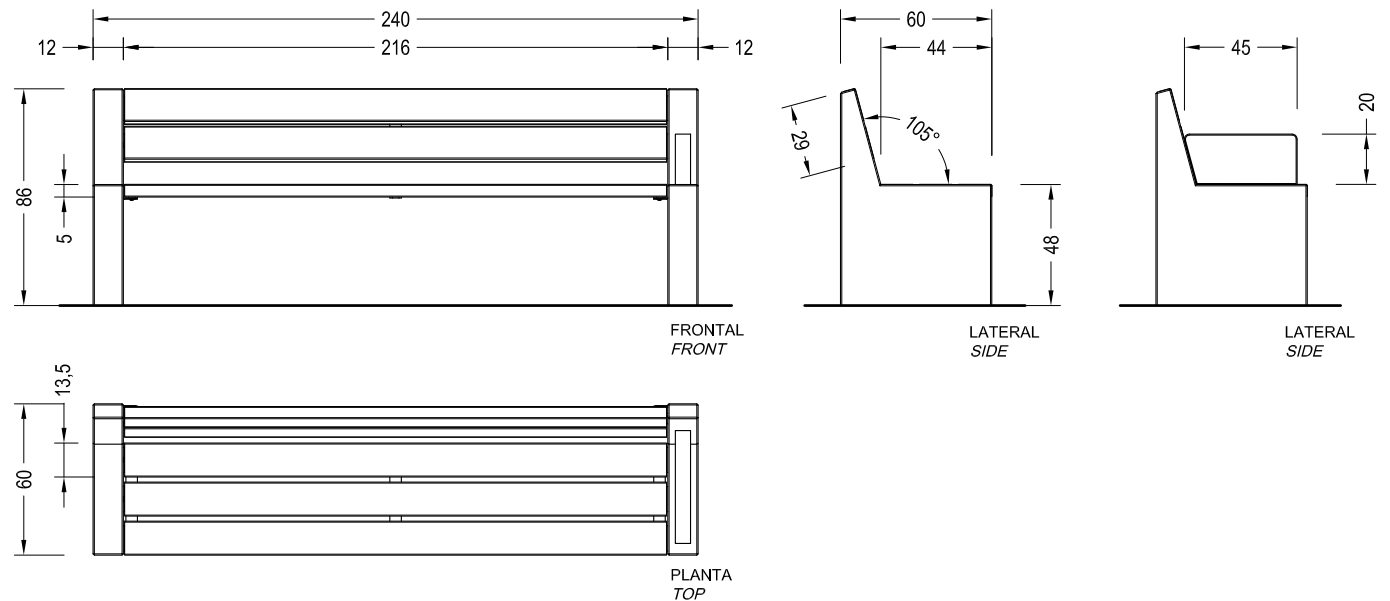

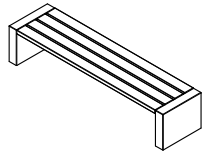

Ref.ALPINE-01

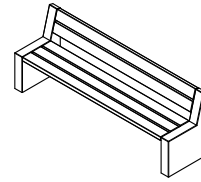

Ref.ALPINE-02

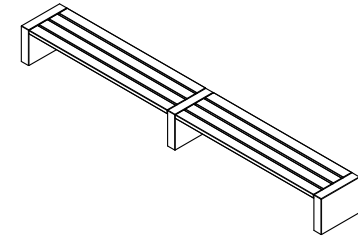

Ref.ALPINE-03

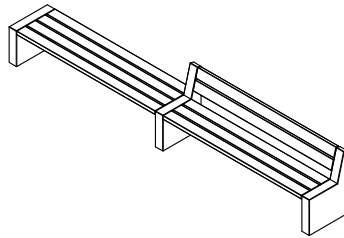

Ref.ALPINE-04

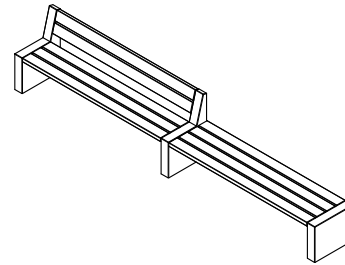

Ref.ALPINE-05

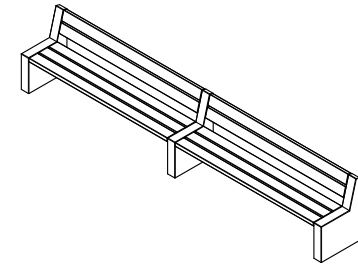

Ref.ALPINE-06

