

# CARACTERÍSTICAS / CHARACTERISTICS

**MATERIAL** madera tropical certificada FSC®  
**ACABADO** tratado con aceite translúcido  
**SOPORTES** acero zincado / acero inoxidable  
**ACABADO** pintado plata texturizado / -  
**COLOC.** anclado con tacos de expansión  
**PESO** banco 38kg / silla 19,5kg  
 banca 28kg / asiento 16kg

**MATERIAL** tropical wood FSC® certified  
**FINISH** treated with translucent oil  
**SUPPORTS** zinc plated steel / stainless steel  
**FINISH** textured silver coated / -  
**FIXING** anchored with expansion bolts  
**WEIGHT** bench 38kg / chair 19,5kg  
 backless bench 28kg / seat 16kg

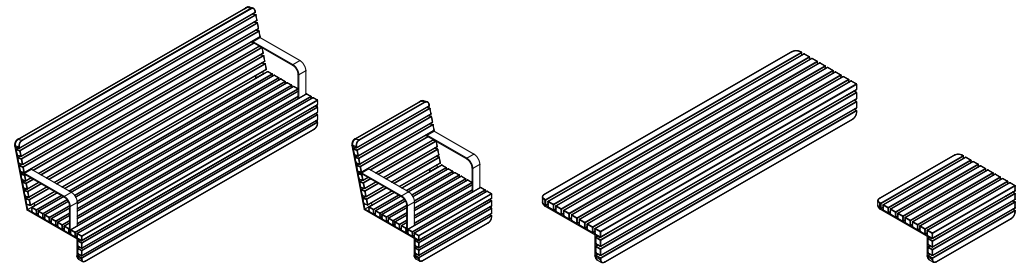

Update 10/01/2020  
 Cotas / Sizes cm

## INSTALACIÓN / INSTALLATION

Centrar y colocar el accesorio sobre el banco o muro y marcar agujeros colísimos  
 Center and place the accessory on the bench or retaining wall and mark the slotted holes

E:1/20

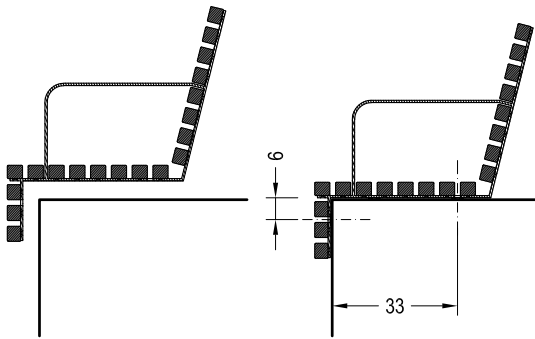

Taladrar el banco o muro y situar el accesorio  
 Drill bench or retaining wall and place the accessory

E:1/40

Insertar y roscar los 4 o 6 tacos de expansión 8 x 45mm  
 Insert and tightly 4 or 6 expansion bolts 8 x 45mm

Incorpora arandelas de nylon para separar la madera del soporte  
 Includes nylon washers to separate the wood from the support

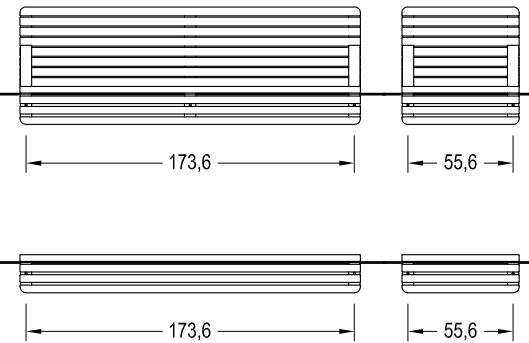

## GEOMETRÍA / GEOMETRY

A. UNIVERSE banco / bench

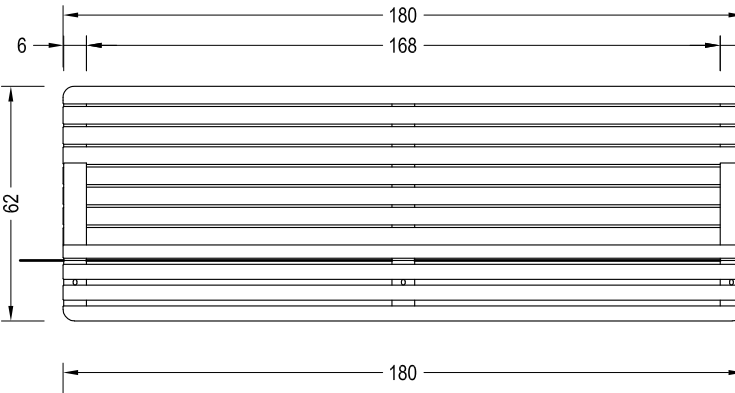

B. UNIVERSE silla / chair

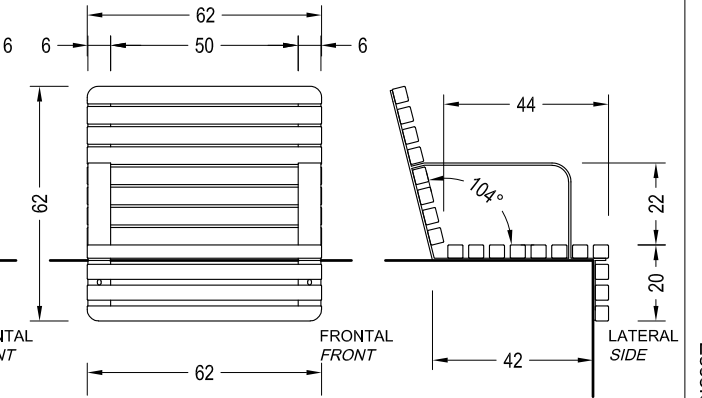

E:1/20

C. UNIVERSE banca / backless bench

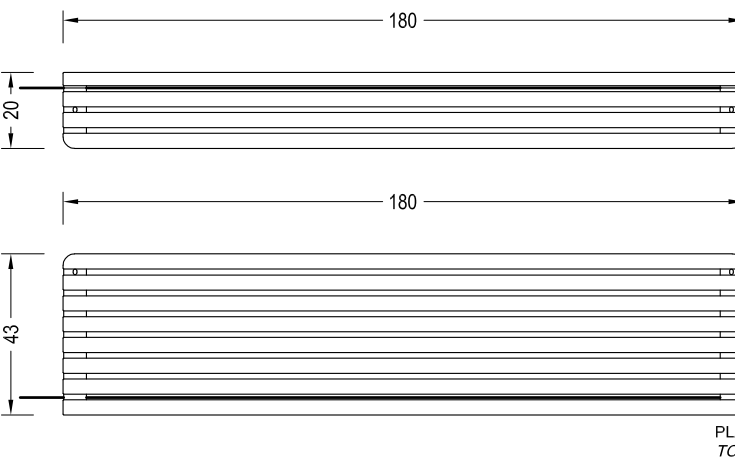

D. UNIVERSE asiento / seat

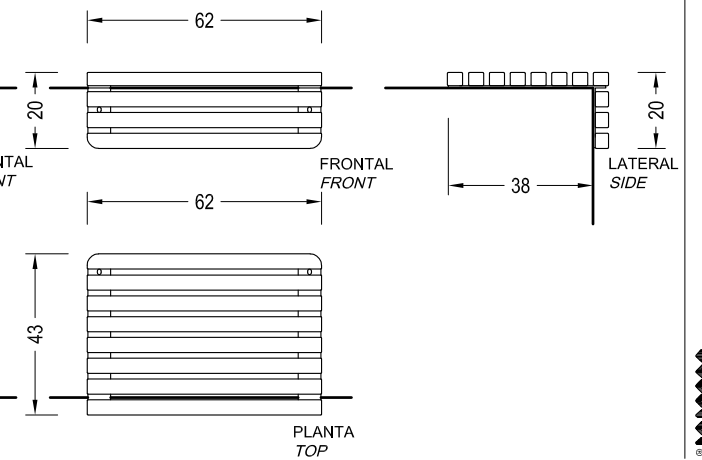

SOCRATES + UNIVERSE

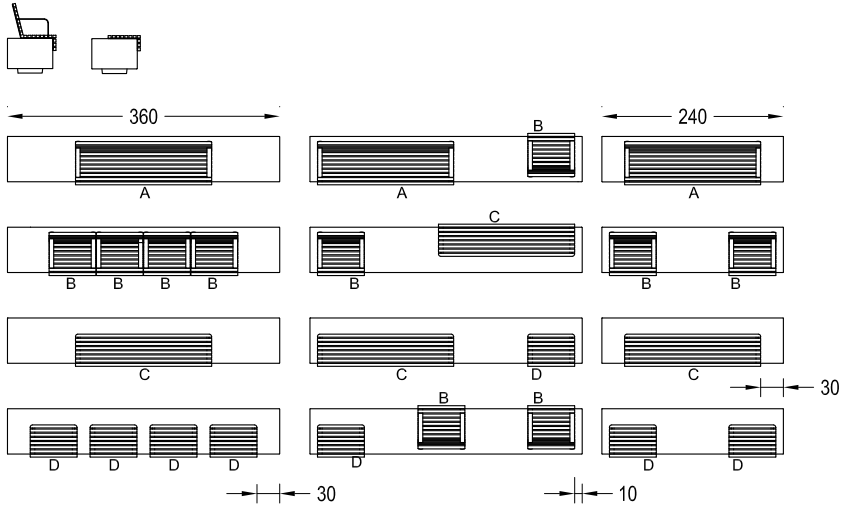

BOX + UNIVERSE

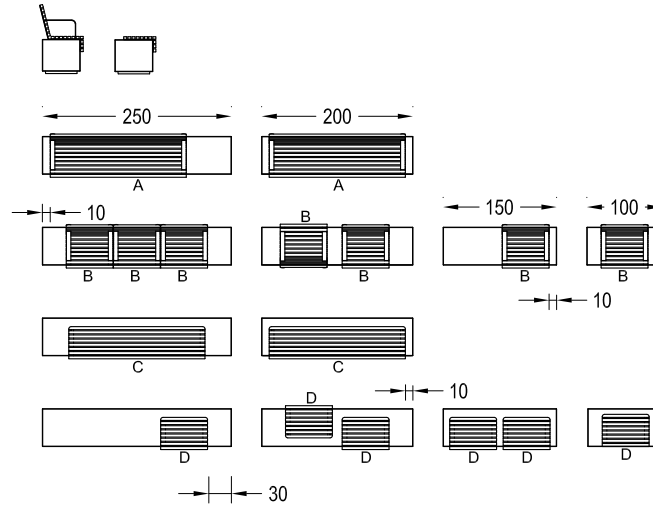

GARONNE + UNIVERSE

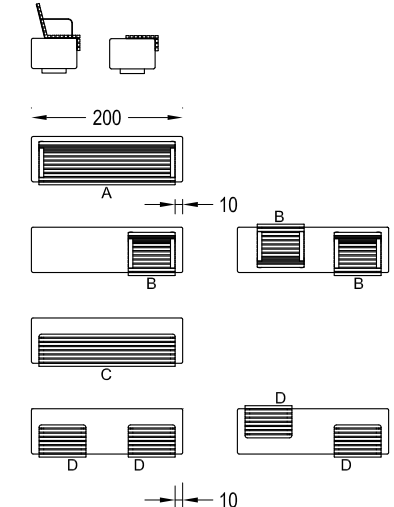

LONGO + UNIVERSE

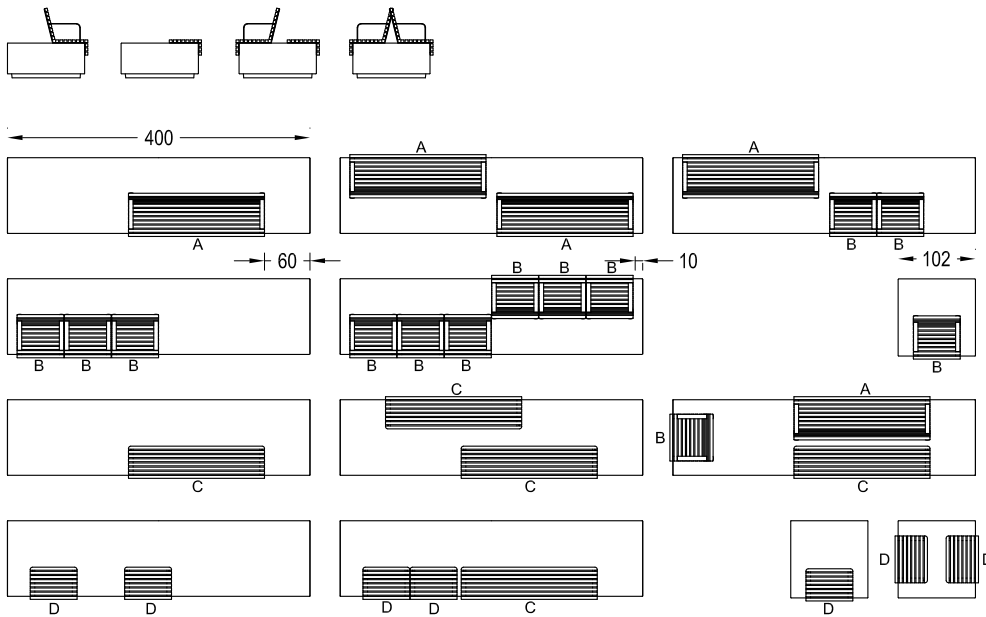

GODOT + UNIVERSE

