

CARACTERÍSTICAS / CHARACTERISTICS

MATERIAL hormigón
 COLOR carta de colores estándar
 ACABADO pulido e hidrofugado /
 decapado e hidrofugado
 COLOC. apoyado sin anclaje
 PESO banca 2670kg / cubo 725 kg

MATERIAL concrete
 COLOUR standard colour chart
 FINISH polished and waterproofed /
 etched and waterproofed
 FIXING free-standing
 WEIGHT bench 2670 kg / cube 725 kg

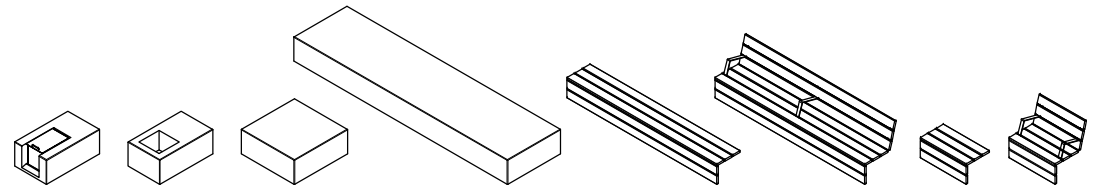

Update 12/02/2020
 Cotas / Sizes cm

INSTALACIÓN / INSTALLATION

elevación / hoisting
 P = 2670kg / 725 kg
 elevación con eslingas de poliéster /
 hoisting with polyester slings

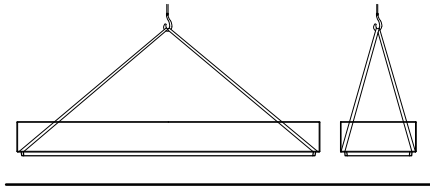

E:1/100

GEOMETRÍA / GEOMETRY

E:1/30

LONGO BANCA

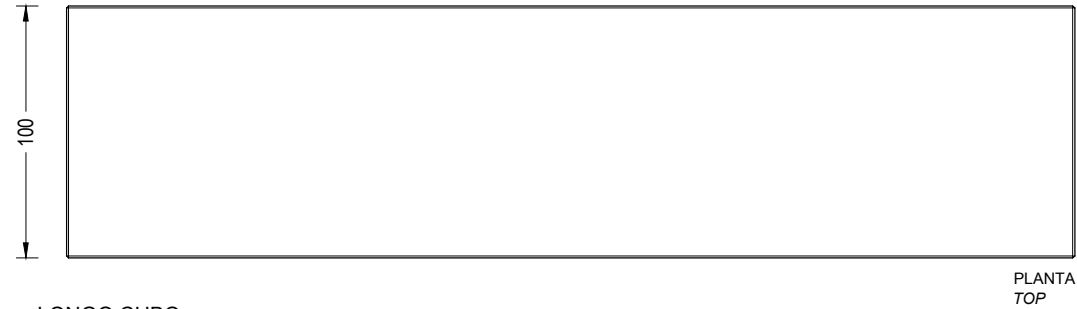
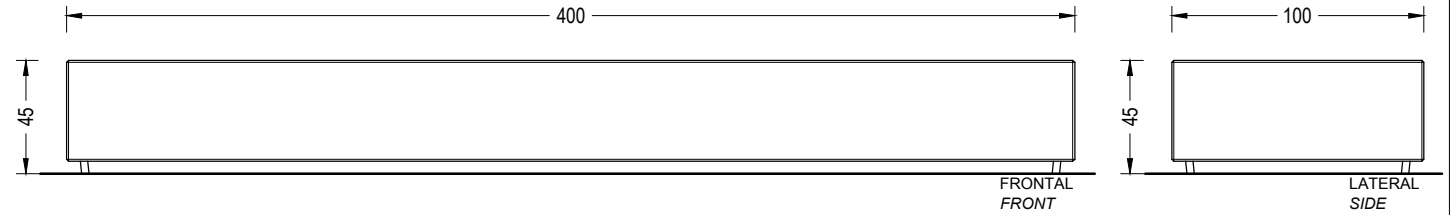

LONGO CUBO

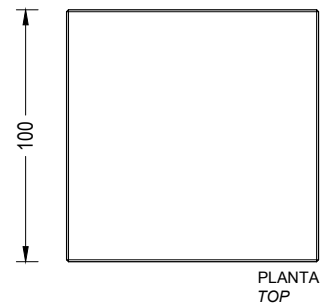
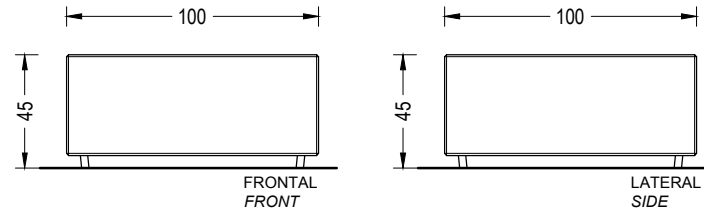

CARACTERÍSTICAS / CHARACTERISTICS

MATERIAL hormigón
 COLOR carta de colores estándar
 ACABADO pulido e hidrofugado /
 decapado e hidrofugado
 COLOC. apoyado sin anclaje
 PESO banca 2670kg / cubo 725 kg

MATERIAL concrete
 COLOUR standard colour chart
 FINISH polished and waterproofed /
 etched and waterproofed
 FIXING free-standing
 WEIGHT bench 2670 kg / cube 725 kg

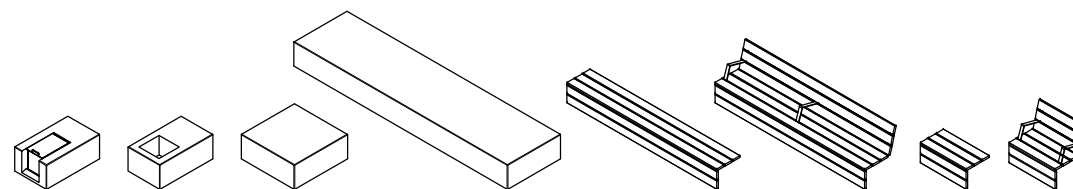

Update 12/02/2020
 Cotas / Sizes cm

INSTALACIÓN / INSTALLATION

E:1/40

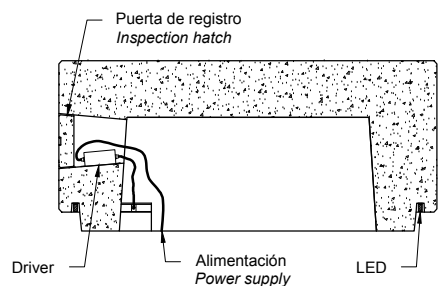

SECCIÓN REGISTRO
 ELECTRICAL BOX SECTION

LED	
Tensión de trabajo <i>Operating voltage</i>	24V
Potencia <i>Power</i>	8W/m
Temperatura de color <i>Color temperature</i>	6000K
Grado de protección <i>Degree of protection</i>	IP67

Driver Vossloh o similar <i>Driver Vossloh or similar</i>	
Potencia <i>Power</i>	30W / 75W
Voltage <i>Voltage</i>	220-240V
Frecuencia <i>Frequency</i>	50-60Hz
Factor de potencia <i>Power factor</i>	>0,9
Grado de protección <i>Degree of protection</i>	IP67

GEOMETRÍA / GEOMETRY

E:1/30

LONGO BANCA LED

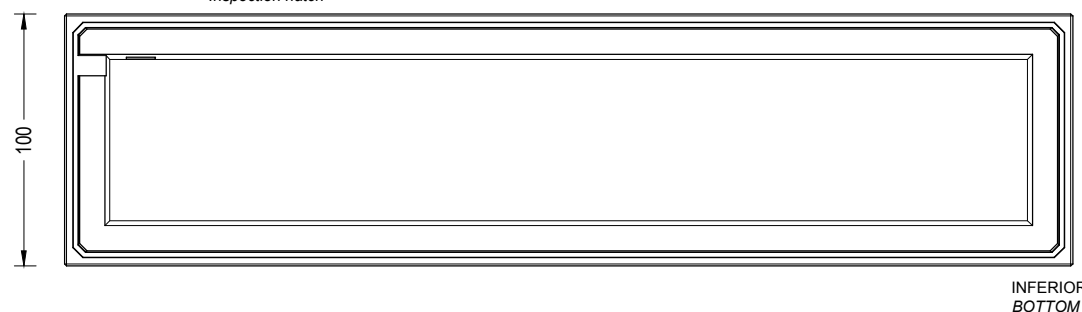
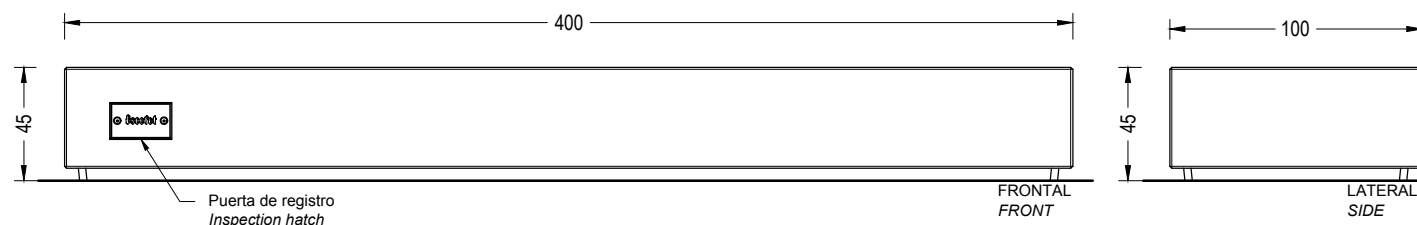

LONGO CUBO LED

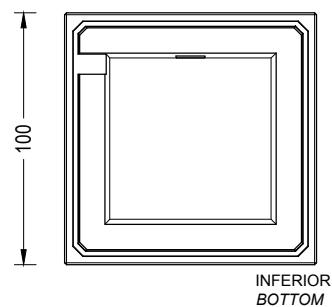
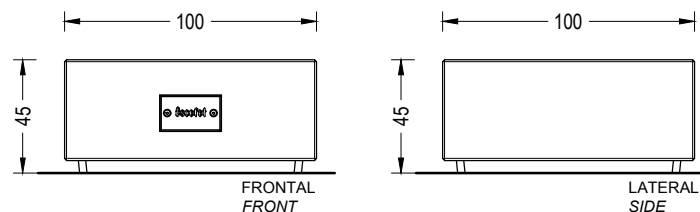

CARACTERÍSTICAS / CHARACTERISTICS

MATERIAL hormigón
COLOR carta de colores estándar
ACABADO pulido e hidrofugado /
 decapado e hidrofugado
CUBETAS acero inoxidable
COLOC. apoyado sin anclaje
PESO papelera 555 kg
 cenicero 575 kg

MATERIAL concrete
COLOUR standard colour chart
FINISH polished and waterproofed /
 etched and waterproofed
BUCKET stainless steel
FIXING free-standing
WEIGHT litter bin 555 kg
 ashtray 575 kg

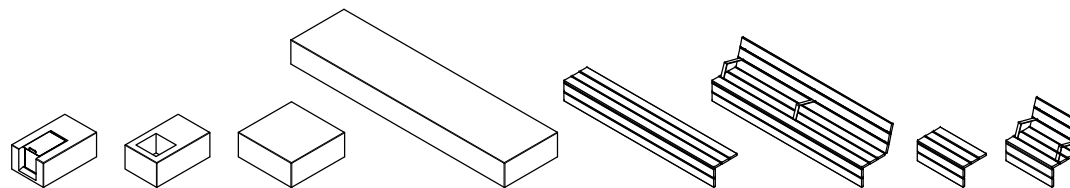

Update 12/02/2020
 Cotas / Sizes cm

INSTALACIÓN / INSTALLATION

elevación / hoisting
 P = 555 kg / 575 kg

elevación con eslingas de poliéster /
 hoisting with polyester slings

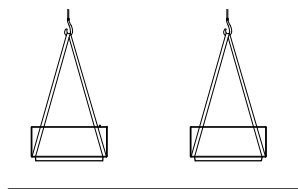

E:1/100

GEOMETRÍA / GEOMETRY

E:1/30

LONGO PAPELERA

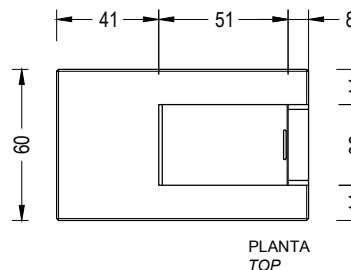
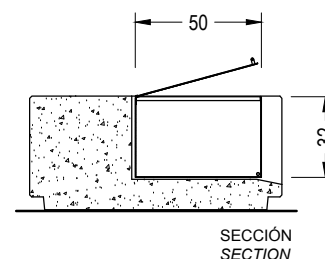
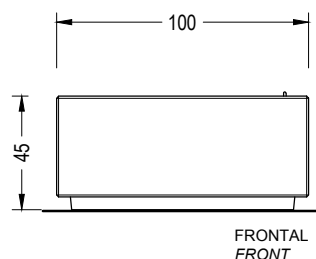
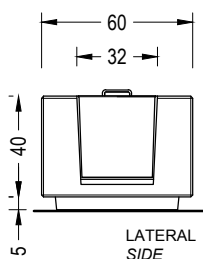

LONGO CENICERO

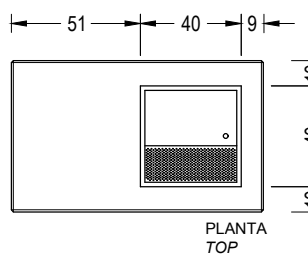
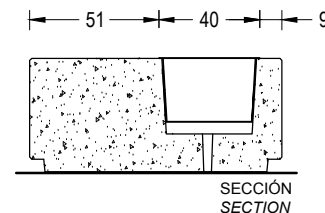
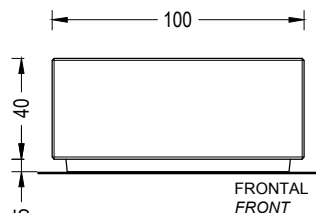
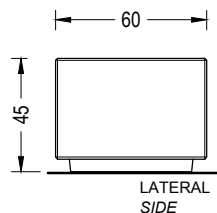

CARACTERÍSTICAS / CHARACTERISTICS

MATERIAL madera tropical certificada FSC®
ACABADO tratada con lasur
SOPORTES acero zincado / acero inoxidable
ACABADO pintado color plata texturizado / inox
COLOC. apoyado sin anclaje
PESO acc. banca 43 kg
 acc. banco 88 kg
 acc. asiento 17 kg
 acc. silla 34 kg

MATERIAL tropical wood FSC® certified
FINISH treated with lasur
SUPPORTS zinc plated steel / stainless steel
FINISH textured silver coated finish
FIXING free-standing
WEIGHT acc. backless bench 43 kg
 acc. bench 88 kg
 acc. seat 17 kg
 acc. chair 34 kg

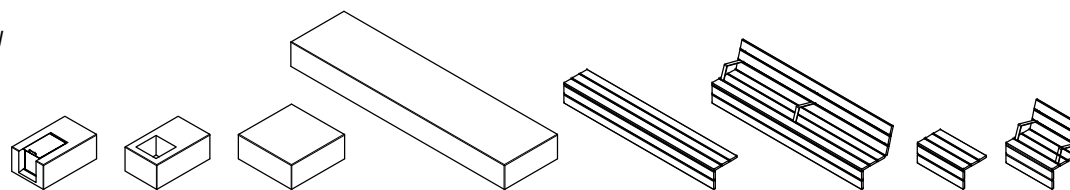

Update 12/02/2020
 Cotas / Sizes cm

GEOMETRÍA / GEOMETRY

E:1/30

ACCESORIO BANCO

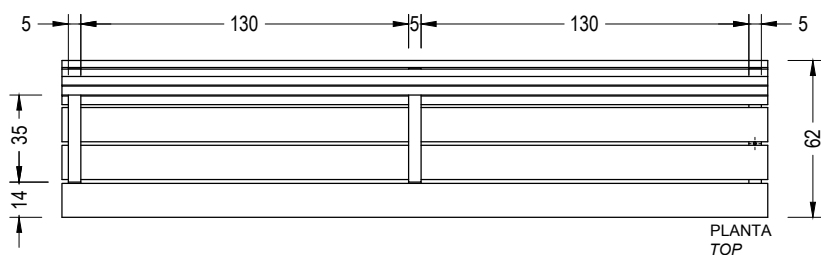
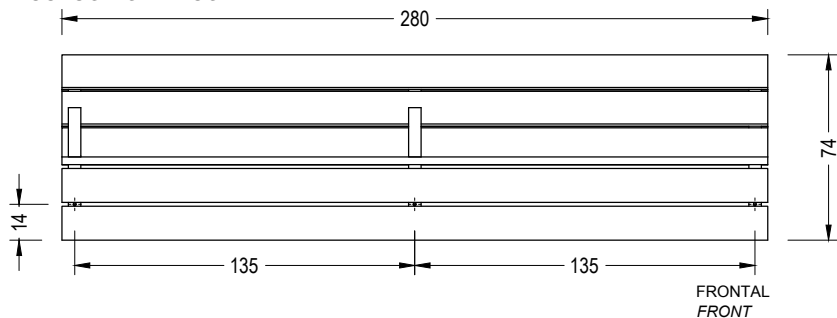

ACCESORIO BANCA

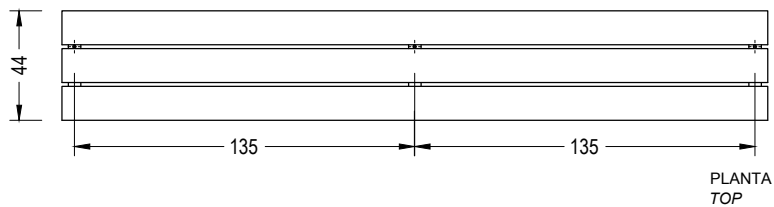
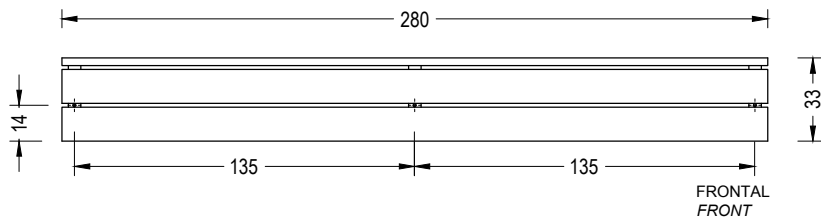

ACCESORIO SILLA

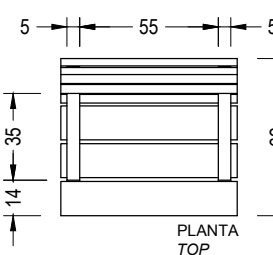
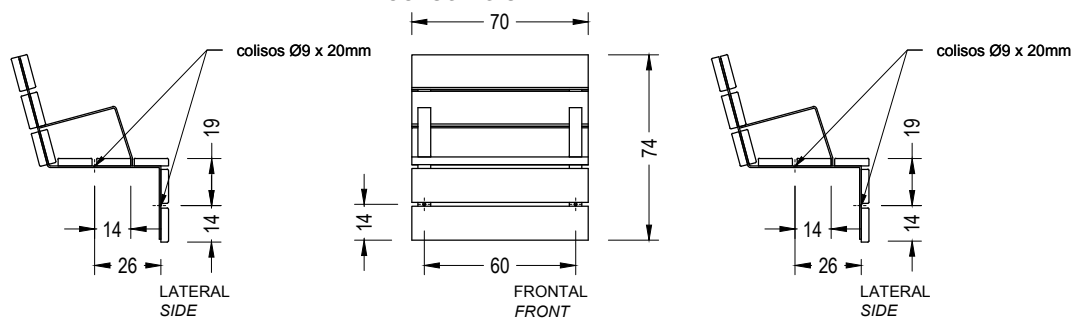

ACCESORIO ASIENTO

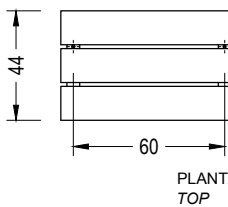
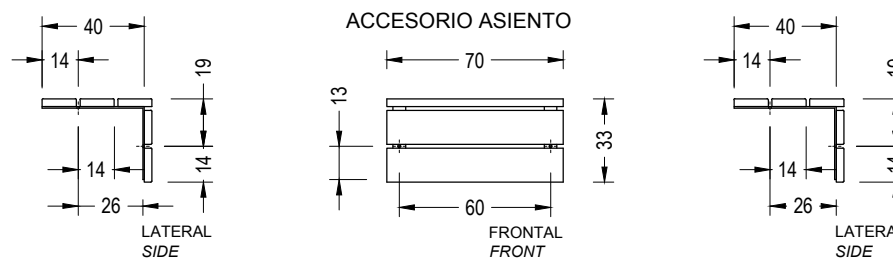

CARACTERÍSTICAS / CHARACTERISTICS

MATERIAL hormigón
COLOR carta de colores estándar
ACABADO pulido e hidrofugado /
 decapado e hidrofugado
ASIENTO madera tropical certificada FSC®
ACABADO tratada con lasur
REPOSA- acero zincado
BRAZOS pintado color plata texturizado
COLOC. apoyado sin anclaje

MATERIAL concrete
COLOUR standard colour chart
FINISH polished and waterproofed /
 etched and waterproofed
SEAT tropical wood FSC® certified
FINISH treated with lasur
ARMREST zinc plated steel
FINISH textured silver coated finish
FIXING free-standing

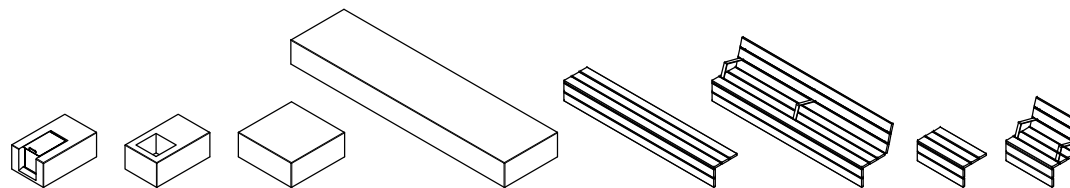

Update 12/02/2020
 Cotas / Sizes cm

AGREGACIÓN / AGGREGATION

E:1/200

1. Banca / Backless bench
2. Cubo / Cube
3. Accesorio Banco / Bench
4. Accesorio Banca / Backless bench
5. Accesorio Silla / Chair
6. Accesorio Asiento / Seat
7. Papelera / Litter Bin
8. Cenicero / Ashtray

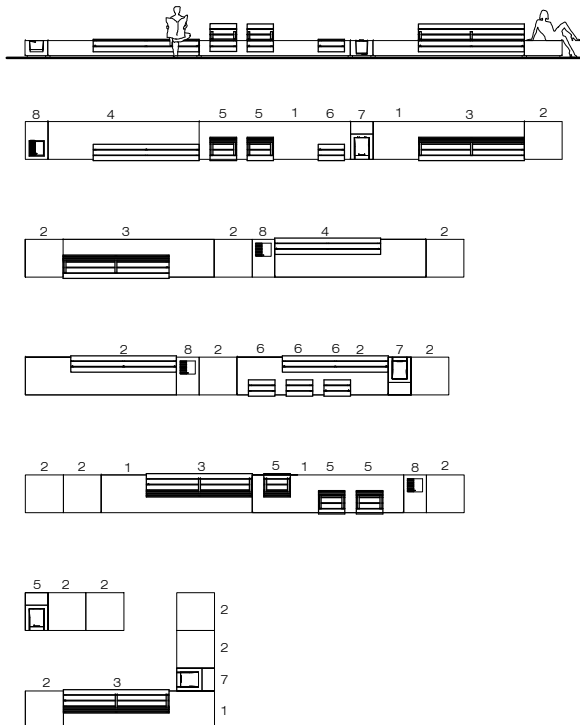

GEOMETRÍA / GEOMETRY

E:1/40

LONGO BANCA + ACCESORIO BANCA + ACCESORIO ASIENTO (2730 kg)

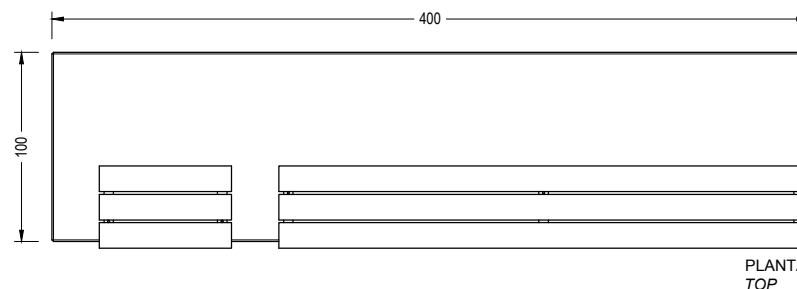
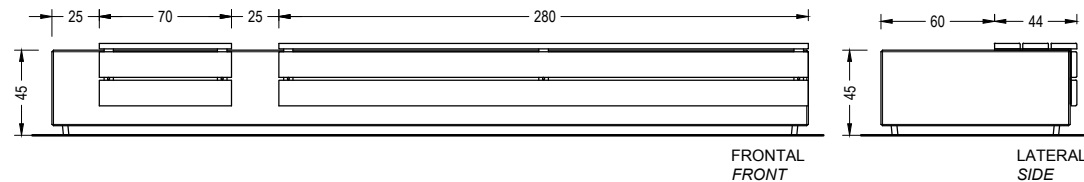

LONGO BANCA LED + ACCESORIO BANCO (2758 kg)

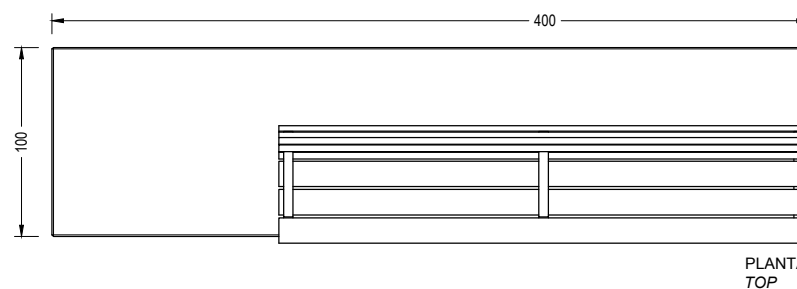
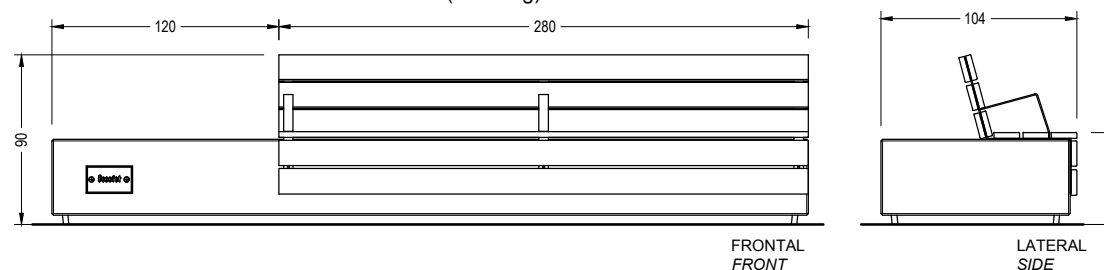

SOCRATES + ACC. LONGO

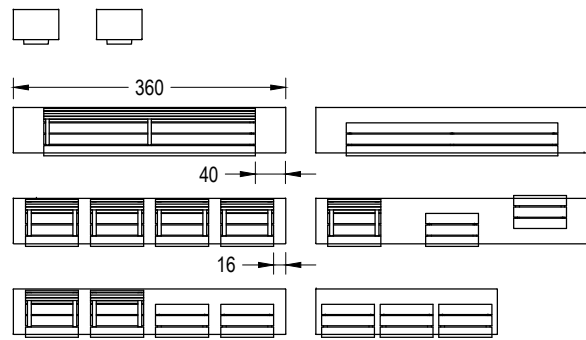

BOX + ACC. LONGO

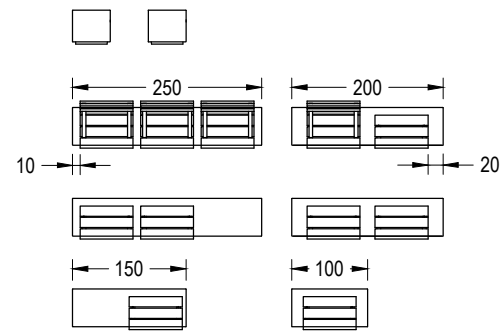

GARONNE + ACC. LONGO

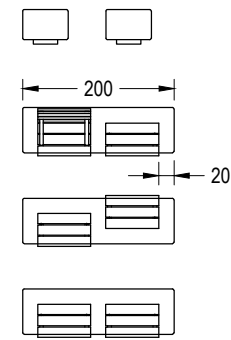

BARANA + ACC. LONGO

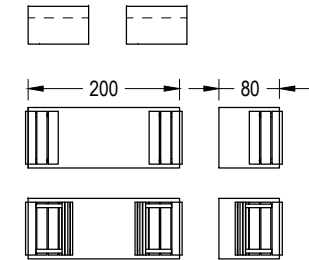

GODOT + ACC. LONGO

