

**CARACTERÍSTICAS / CHARACTERISTICS**

**MATERIAL** hormigón  
**ACABADO** decapado e hidrofugado  
**COLOC.** apoyado sin anclaje  
**PESO** Kushi: 767 kg  
 Kushi End: 685 kg  
 Kushi Line Extension: 607 kg  
 Kushi Dot (1p): 1082 kg

**MATERIAL** concrete  
**FINISH** etched and waterproofed  
**FIXING** free-standing  
**WEIGHT** Kushi: 767 kg  
 Kushi End: 685 kg  
 Kushi Line Extension: 607 kg  
 Kushi Dot (1p): 1082 kg

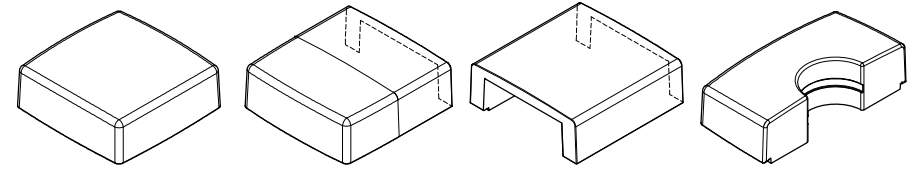

Update 21/02/2020  
 Cotas / Sizes cm

**INSTALACIÓN / INSTALATION**

**GEOMETRÍA / GEOMETRY**

E:1/50

elevación / hoisting  
 (P=767 kg / 607 kg / 685 kg / 1082 kg)

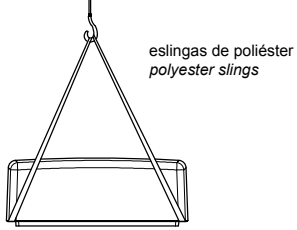

eslingas de poliéster  
 polyester slings

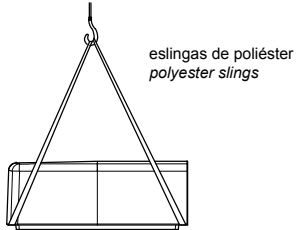

eslingas de poliéster  
 polyester slings

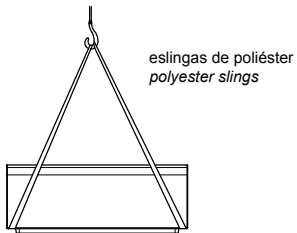

eslingas de poliéster  
 polyester slings

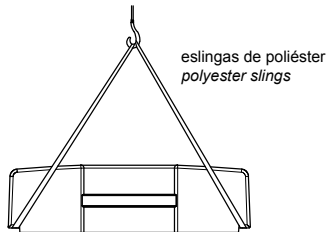

eslingas de poliéster  
 polyester slings

**BANCO APOYADO SIN ANCLAJE  
 FREE-STANDING BENCH**

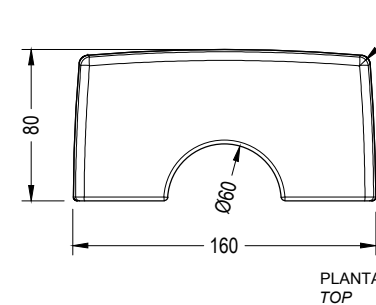
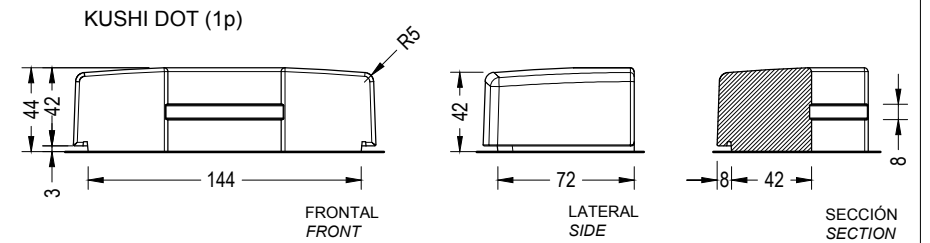
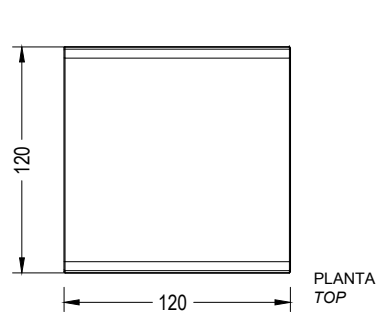
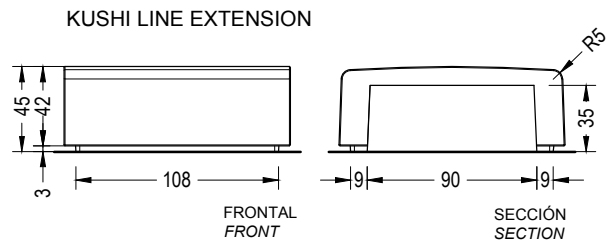
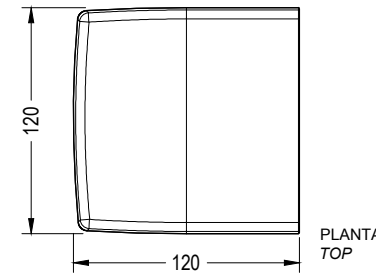
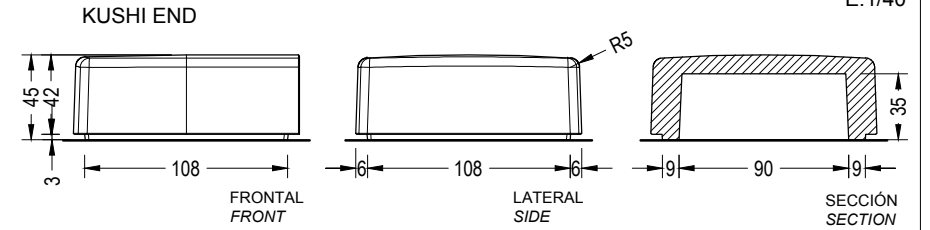
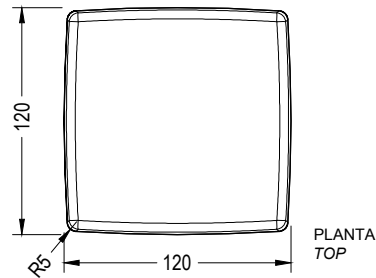
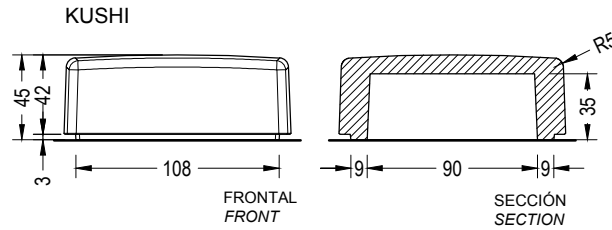

E:1/40

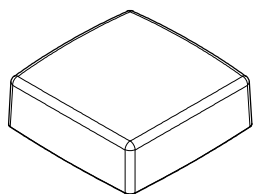

KUSHI

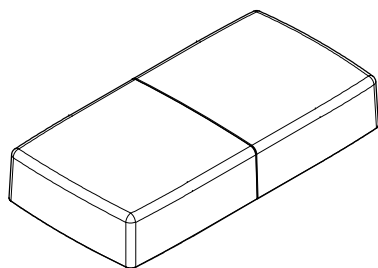

KUSHI DUPLO

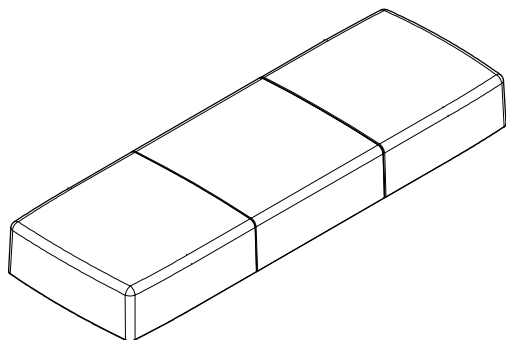

KUSHI LINE

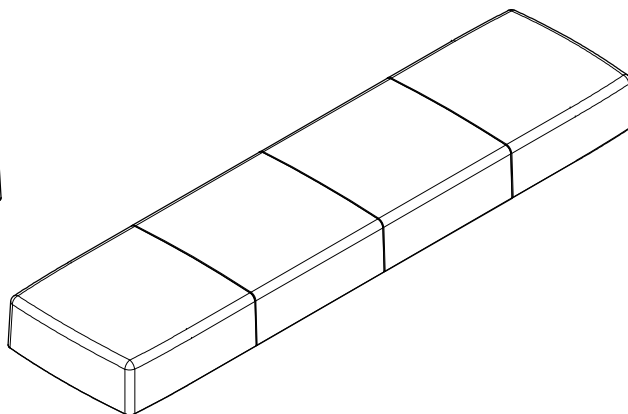

KUSHI LINE + 1 EXTENSION

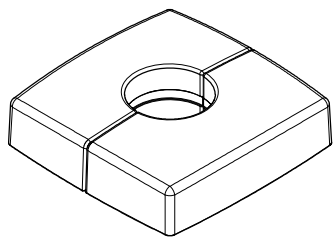

KUSHI DOT

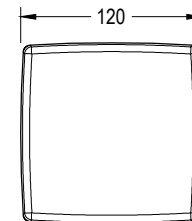

KUSHI

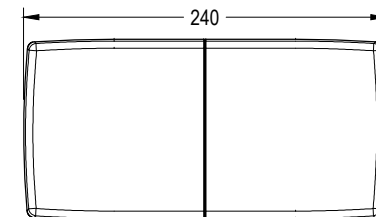

KUSHI DUPLO  
2 ud. KUSHI END

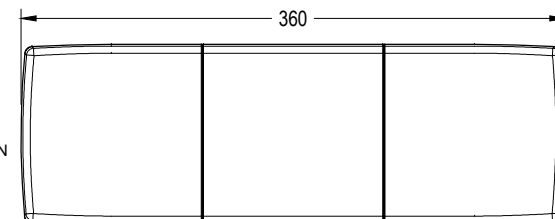

KUSHI LINE  
2 ud. KUSHI END  
1 ud. KUSHI LINE EXTENSION

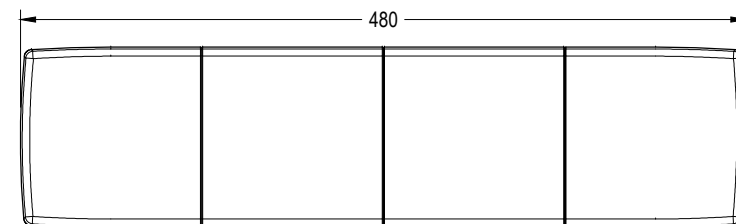

KUSHI LINE + 1 EXTENSION  
2 ud. KUSHI END  
2 ud. KUSHI LINE EXTENSION

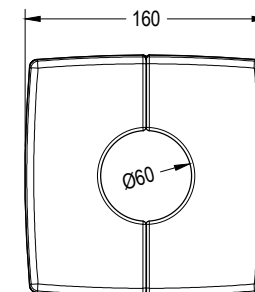

KUSHI DOT  
2 ud. KUSHI DOT