



The *Modular* bench is the outcome of the industrialisation of the bench around the perimeter that defines the boundary of the raised square on top of the hypostyle construction in Park Güell, Barcelona and makes the most of all the modular combinatorial and latent spatial options of the original design, adapting its ergonomics to current demands.

Concrete | Modular |  260 cm/max |  960 kg |  5

 Update 08.06.2020



Origin

It is inspired by the shapes of the perimeter bench designed by Antoni Gaudí and Josep Maria Jujol to crown the hypostyle construction in Park Güell, Barcelona.

Design

The bench has three versions: the linear version, with two straight modular lengths, and the concave and convex modular versions, which offer the possibility of creating extremely pliable sine wave alignments. The combination of benches with different concave and convex radii and straight benches allows us to draw any figure on the landscape.

Versatility

The Modular bench functions as an undulated or straight delimiting bench and the combination of both can be used to form isolated aggregations or as a retaining wall

in green areas, creating a boundary between the space of passage and the green space or encircling trees. It also has straight and undulated benches in double versions.

Ergonomic

The combined back and seat profile adapts perfectly to the ergonomics of its users.

Material

Non-reinforced dry-mix concrete with a etched finish, in the Escofet catalogue standard chart colours.

Installation

It simply rests on the paving or on compacted sand. In the case of aggregating the *Modular* benches in garden areas, it is advisable to seal the vertical joints between modules. Drainage or elimination of rainwater is done through the channel in the seat which in turn drains the water out through the joints between the benches.



MODULAR



Escofet®



1. Bench

Modular Straight		
Dimensions*	175 175 x 64 x 40 (71) cm	260 260 x 64 x 40 (71) cm
Weight	175 960 kg	260 1430 kg
Modular 90°		
	Right	Left
Dimensions*	84 x 64 x 40 (71) cm	84 x 64 x 40 (71) cm
Weight	305 kg	305 kg
Modular Curved		
	Concave	Convex
Dimensions*	R190 195 x 79 x 40 (71) cm R865 258 x 72 x 40 (71) cm R3000 264 x 67 x 40 (71) cm	R190 195 x 79 x 40 (71) cm R3000 264 x 67 x 40 (71) cm
Weight	R190 960 kg R865 1790 kg R3000 1820 kg	R190 960 kg R3000 1820 kg
Modular Double		
	Recto	Curvo
Dimensions*	260 260 x 128 x 40 (71) cm	R869 280 x 137 x 40 (71) cm
Weight	260 2860 kg	R869 3375 kg

1.1 General features

Material	Concrete	Fixing	Free-standing
----------	----------	--------	---------------

Finish	Etched and waterproofed
--------	-------------------------

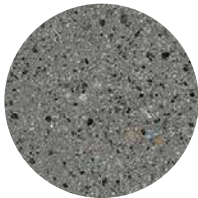
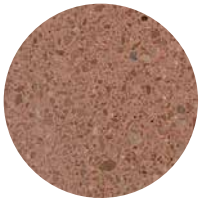
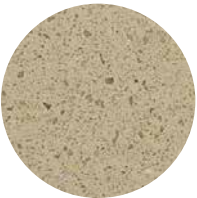
Colours			
	GR. Grey	NG. Black	BL. White
			
	CA. Grey CA	RA. Red	BG. Beige

*Other lengths to consult

1.2 Installation system

Hoisting

(P=305 kg / 960 kg / 1430 kg / 1790 kg / 1820 kg / 2860 kg / 3375 kg)

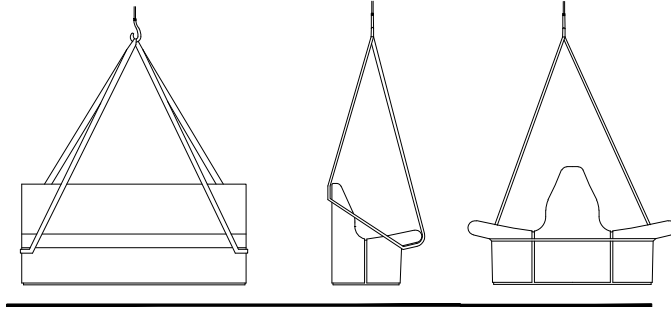

Modular Straight

260

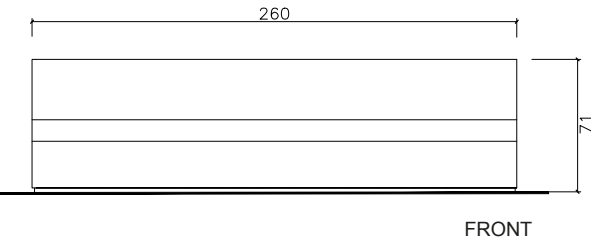

175

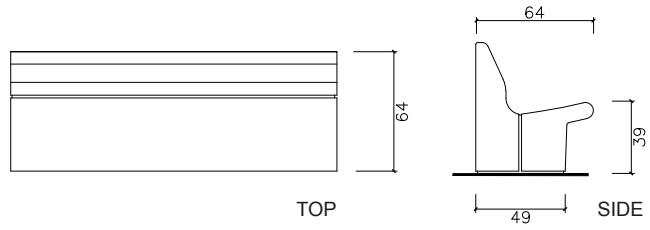
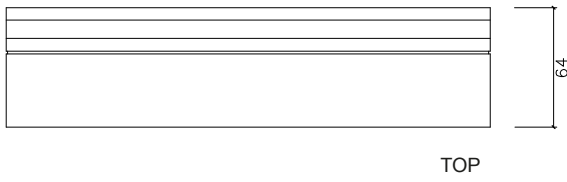
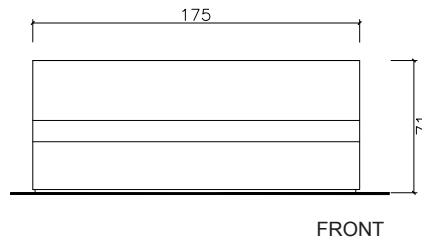

ANGLE 90°

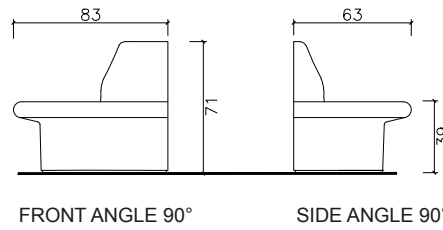
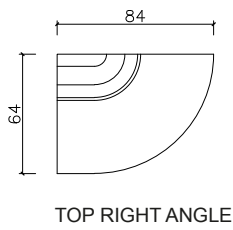
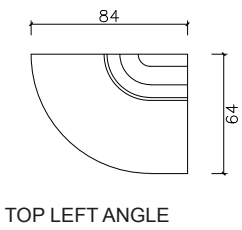

Aggregations

MODULAR STRAIGHT

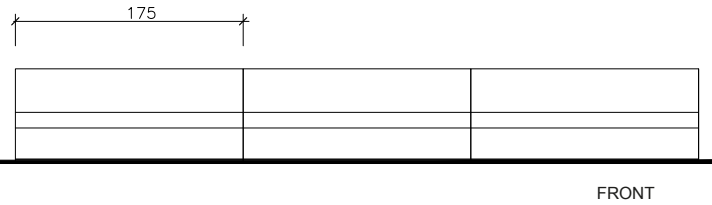

DOUBLE with ANGLE 90

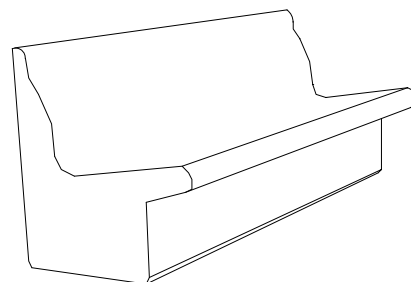
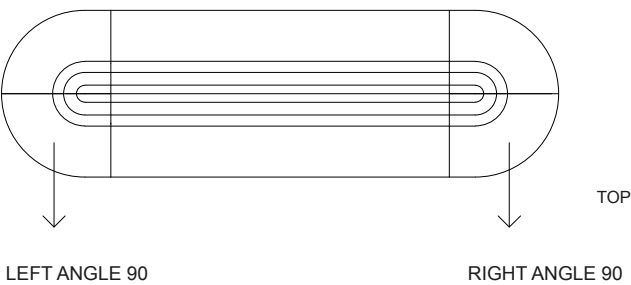

Modular Concave-Convex

CONCAVE R190 / R3000 / R865

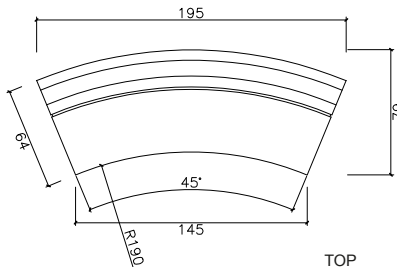
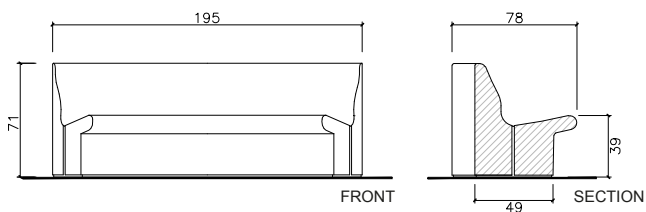

CONVEX R190 / R3000

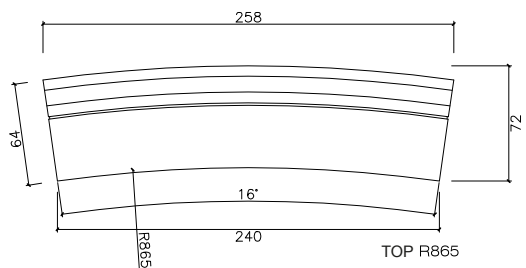
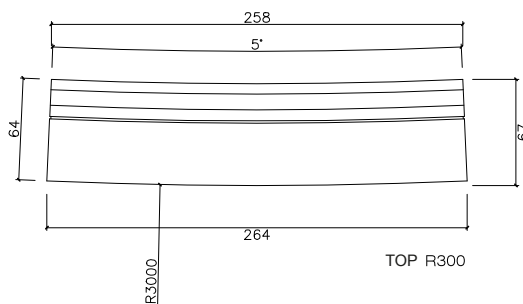
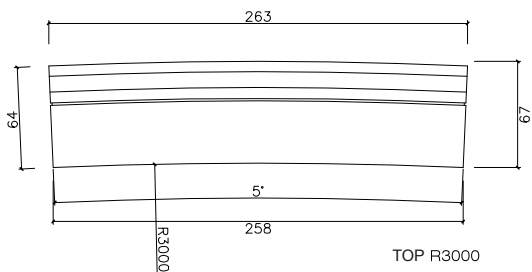
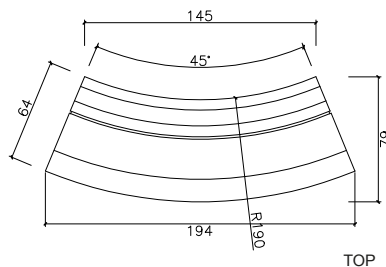
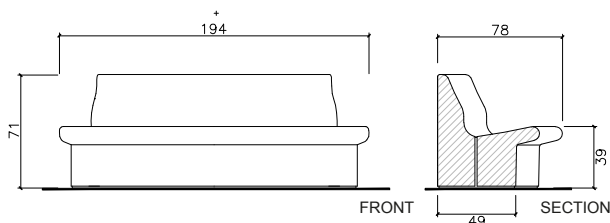

Aggregations

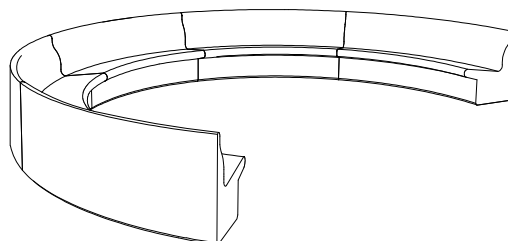
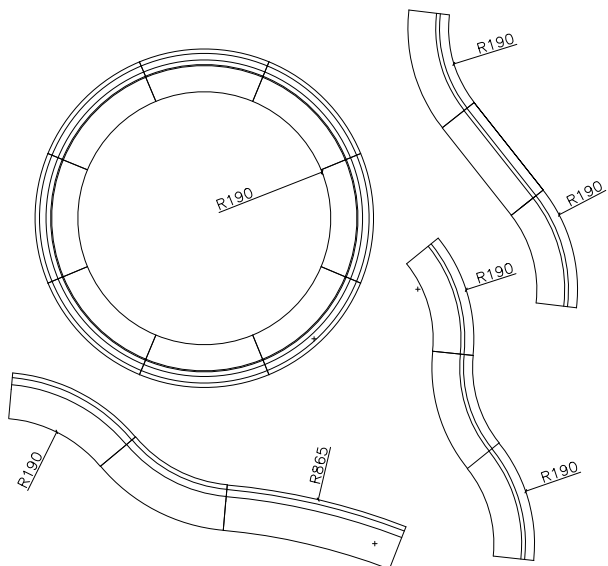

Modular Double Straight - Curved

STRAIGHT DOUBLE 260

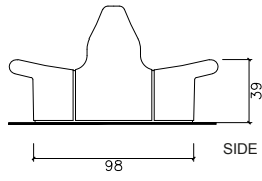
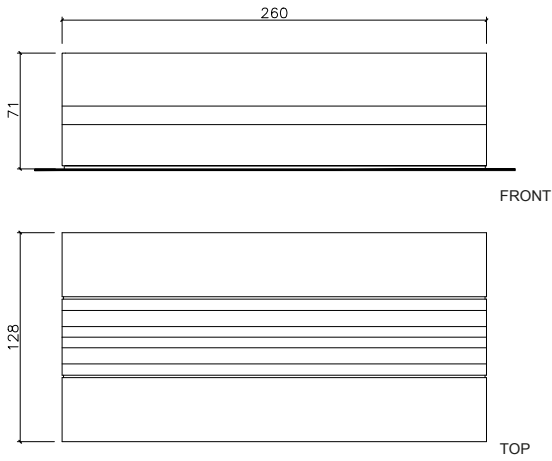

CURVED DOUBLE R869

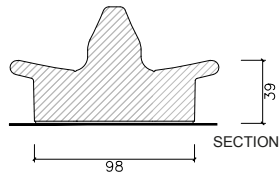
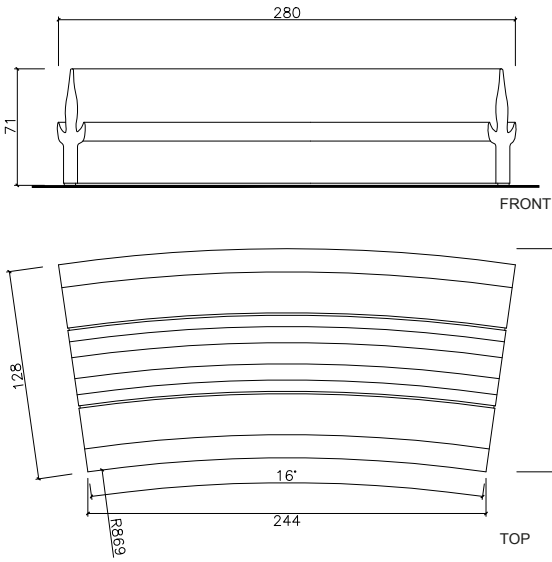

Aggregations

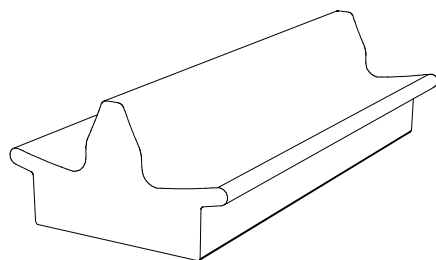
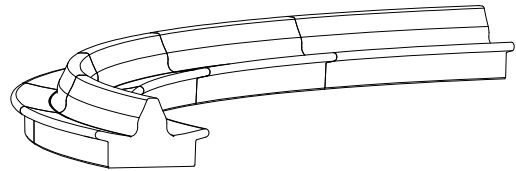
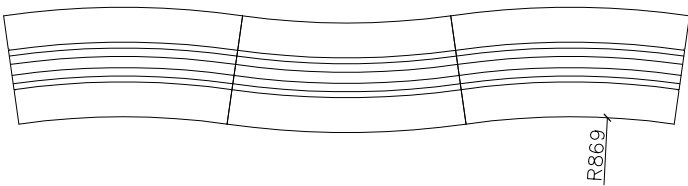



MODULAR

Escofet[®]



Warranty

5 years in all its components.

The names, trademarks and industrial models of the products have been logged in the corresponding registers. The technical information provided by Escofet about its products can be modified without prior notice.

Escofet 1886 S.A
Head office and production

Montserrat, 162
E 08760 Martorell
Barcelona - España
T. 0034 937 737 150
F. 0034 937 737 151

info@escofet.com
www.escofet.com



GA-2005/0072 SST-0090/2010 ER-0403/2016