

## CARACTERÍSTICAS

MATERIAL	Madera tropical FSC® Listones de PPRV RAL 1000 / Otro RAL +20 uds	MATERIAL	Tropical wood FSC® PPRV strips RAL 1000 / Other RAL +20 uds
SOPORTES	Fundición aluminio Pintura color plata	SUPPORT	Cast-aluminium Powder coating silver color
COLOC. PESO	Anclado con tornillos 20 Kg / 35 Kg / 60 Kg	FIXING WEIGHT	Anchored with bolts 20 Kg / 35 Kg / 60 Kg

DISEÑO / DESIGN Leopoldo Milla

## SISTEMA DE COLOCACIÓN

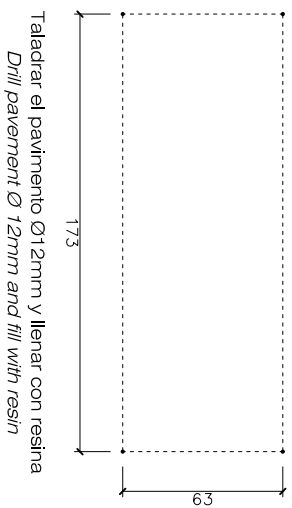
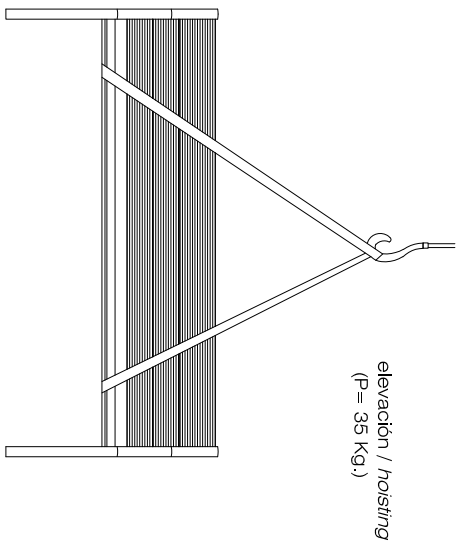

## GEOMETRÍA

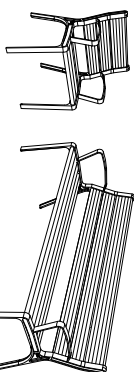

MADERA

PPRV

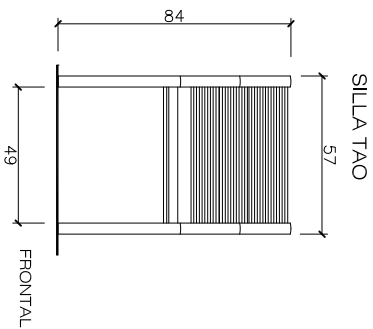

SILLA TAO

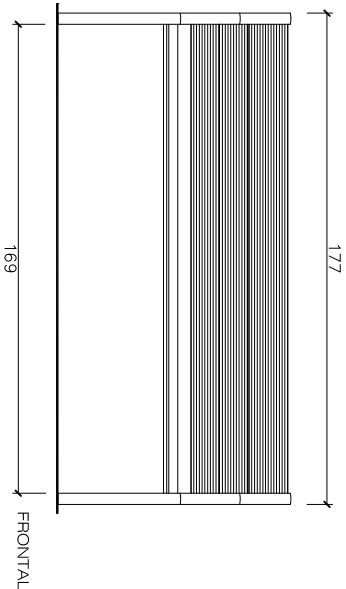

BANCO TAO

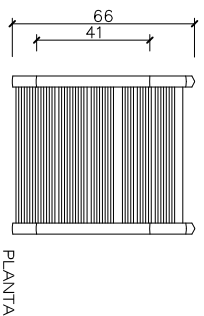

PLANTA

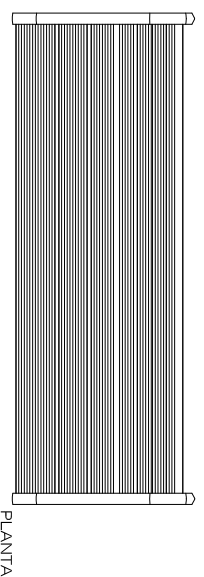

PLANTA

BANCO DOBLE TAO

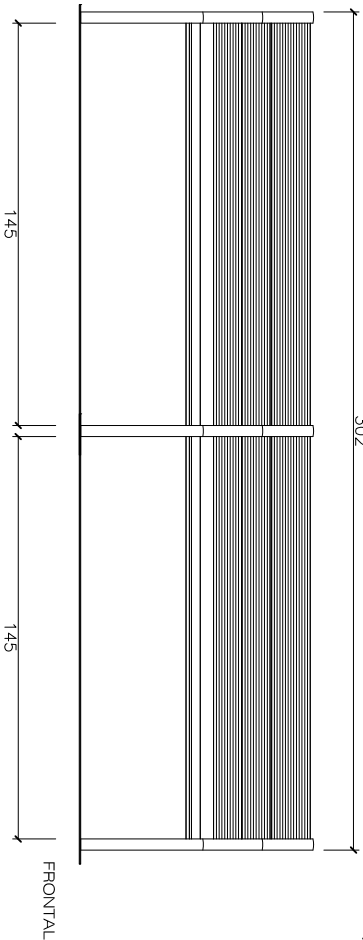

FRONTAL

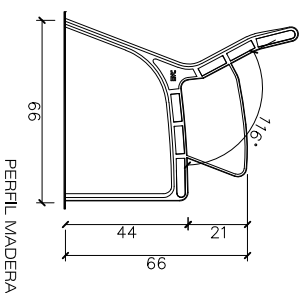

PERFIL MADERA

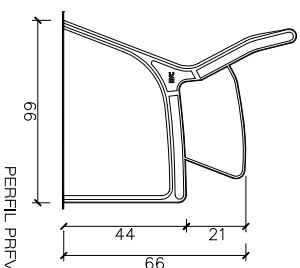

PERFIL PPRV

Roscar los 4 tornillos a fondo DIN 913 M10 x 100  
Tightly screw the 4 bolts DIN 913 M10 x 100

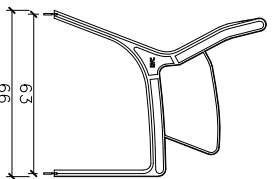

63

66