

CARACTERÍSTICAS / CHARACTERISTICS

MATERIAL hormigón / hormigón reciclado
COLOR carta de colores estándar
ACABADO decapado e hidrofugado
SOPORTES acero inox AISI 316L
ASIENTO madera pino certificada FSC®
 tratado al autoclave y protección fungicida
 madera tropical certificada FSC®
 tratado con aceite
COLOC. anclado con tornillos
PESO sop. banco 95 kg / sop. banca 83 kg

MATERIAL concrete / recycled concrete
COLOUR standard color chart
FINISH etched and waterproofed
SUPPORTS stainless steel AISI 316L
SEAT pine wood FSC® certified
 pressure treated and preventive fungicide
 tropical wood FSC® certified
 treated with oil
FIXING anchored with screws
WEIGHT sup. bench 95 kg / sup. backless bench 83 kg

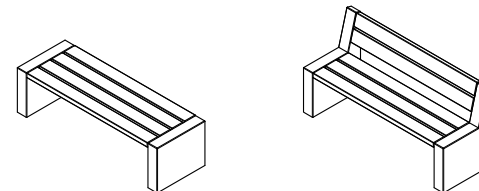

Update 28/02/2020
 Cotas / Sizes cm

INSTALACIÓN / INSTALLATION

ADVERTENCIA. No es manipulable una vez armado
 WARNING. It is not manipulable once armed

Situar los ángulos en los marcos reservados y roscar los tornillos (DIN 7991 M10 x 16mm)
 Place the angles in the reserved frames and tightly screws (DIN 7991M10 x 16mm)

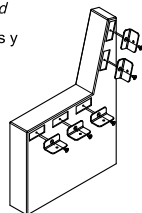

Roscar 2 tornillos a fondo (DIN 931 M16 x 140mm)
 Taladrar el pavimento y llenar de resina o mortero rico
 Tightly screw 2 stud bolts (DIN 931 M16 x 140mm)
 Drill pavement fill with resin or fat mortar

elevación / hoisting
 (P = banco 95 kg / banca 83 kg)

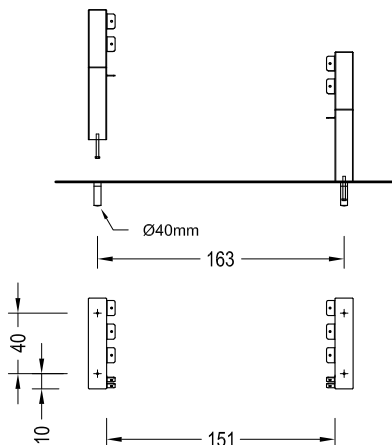

Centrar y colocar el conjunto de listones sobre los soportes.
 Roscar los tornillos (DIN 7360 M8 x 10mm)
 Center and place the set of boards on the bench.
 Tightly screws (DIN 7360 M8 x 10mm)

elevación / hoisting
 (P = banco 13 kg - 18 kg / banca 25 kg)

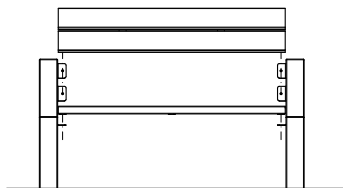

E:1/50

GEOMETRÍA / GEOMETRY

ALPINE Banca 175

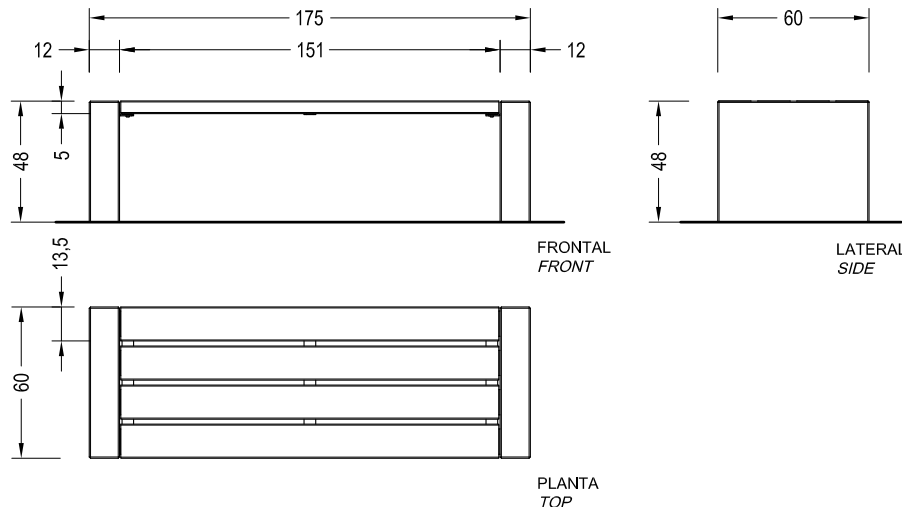

ALPINE Banco 175

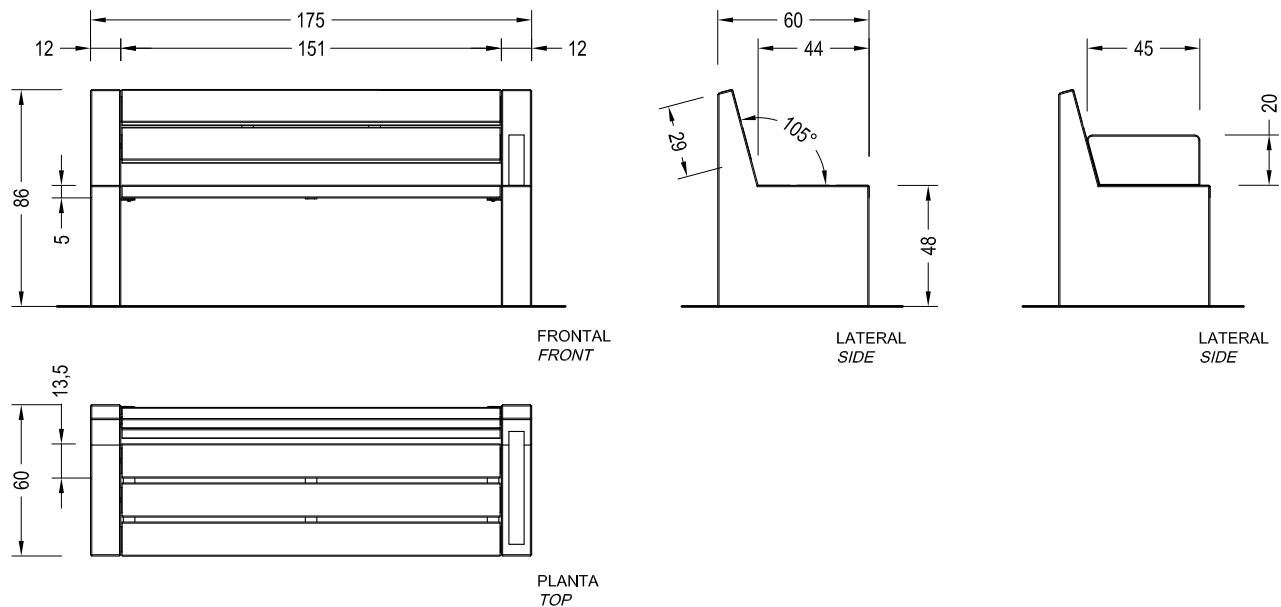

E:1/30

CARACTERÍSTICAS / CHARACTERISTICS

MATERIAL hormigón / hormigón reciclado
COLOR carta de colores estándar
ACABADO decapado e hidrofugado
SOPORTES acero inox AISI 316L
ASIENTO madera pino certificada FSC®
 tratado al autoclave y protección fungicida
 madera tropical certificada FSC®
 tratado con aceite
COLOC. anclado con tornillos
PESO sop. banco 95kg / sop. banca 83kg

MATERIAL concrete / recycled concrete
COLOUR standard color chart
FINISH etched and waterproofed
SUPPORTS stainless steel AISI 316L
SEAT pine wood FSC® certified
 pressure treated and preventive fungicide
 tropical wood FSC® certified
 treated with oil
FIXING anchored with screws
WEIGHT sup. bench 95kg / sup. backless bench 83kg

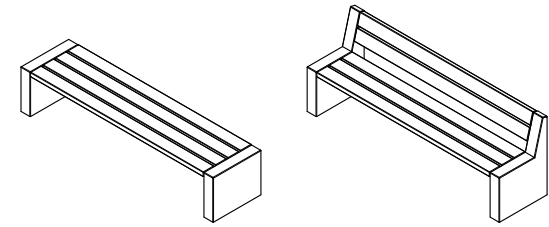

Update 28/02/2020
 Cotas / Sizes cm

INSTALACIÓN / INSTALLATION

ADVERTENCIA. No es manipulable una vez armado
WARNING. It is not manipulable once armed

Situar los ángulos en los marcos reservados y
 rosacar los tornillos (DIN 7991 M10 x 16mm)
*Place the angles in the reserved frames
 and tightly screws (DIN 7991M10 x 16mm)*

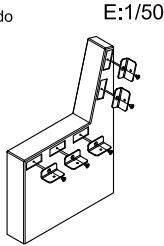

Roscar 2 tornillos a fondo (DIN 931 M16 x 140mm)
 Taladrar el pavimento y llenar de resina o mortero rico
*Tightly screw 2 stud bolts (DIN 931 M16 x 140mm)
 Drill pavement fill with resin or fat mortar*

elevación / hoisting
 (P = banco 95 kg / banca 83 kg)

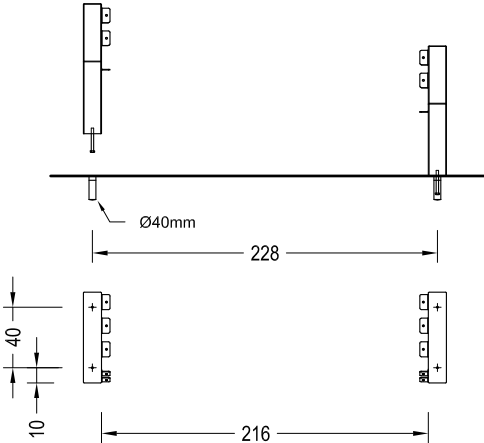

Centrar y colocar el conjunto de listones sobre los soportes.
 Roscar los tornillos (DIN 7360 M8 x 10mm)
*Center and place the set of boards on the bench.
 Tightly screws (DIN 7360 M8 x 10mm)*

elevación / hoisting
 (P = banco 17 kg - 25 kg / banca 33 kg)

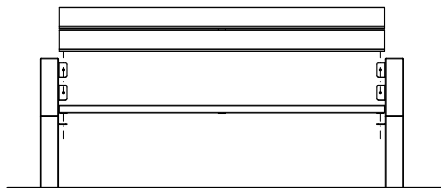

GEOMETRÍA / GEOMETRY

ALPINE Banca 240

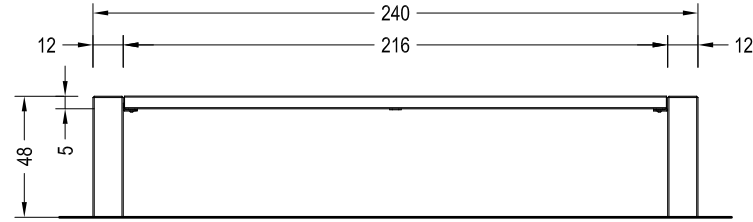

FRONTAL
 FRONT

LATERAL
 SIDE

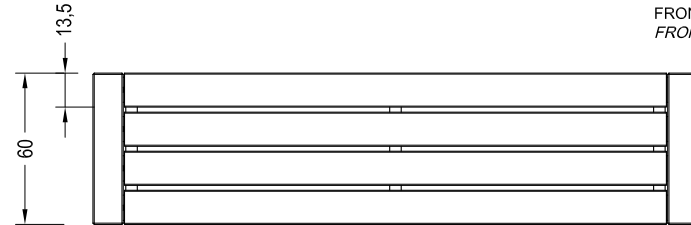

PLANTA
 TOP

ALPINE Banco 240

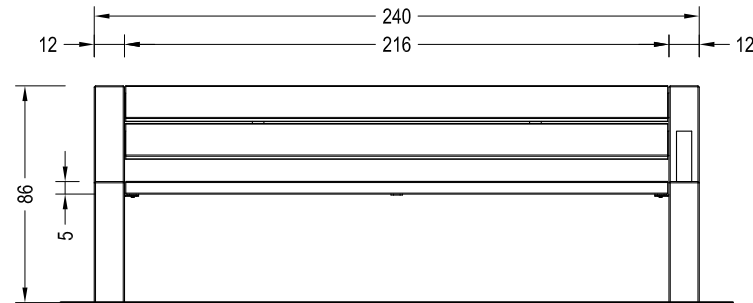

FRONTAL
 FRONT

LATERAL
 SIDE

LATERAL
 SIDE

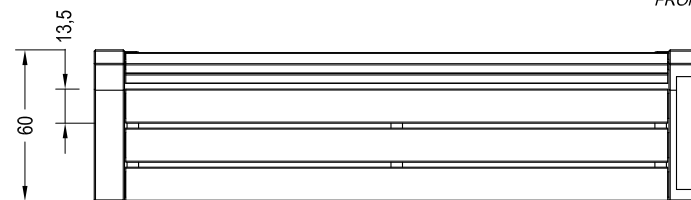

PLANTA
 TOP

Con opción apoyabrazos /
 Optional with armrest

E:1/30

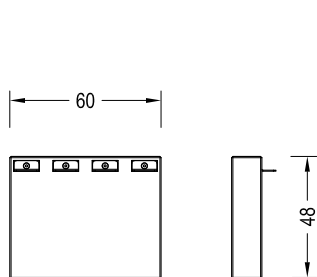

Soporte Banca 83 kg
Ref. ALPINE-BCA-EXT

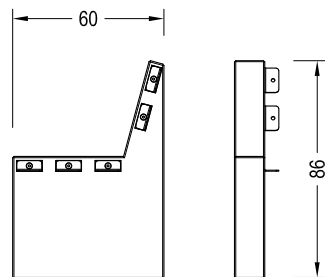
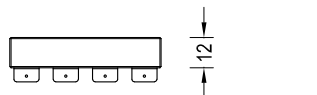

Soporte Banco Derecho 95 kg
Ref. ALPINE-BCO-DRCH

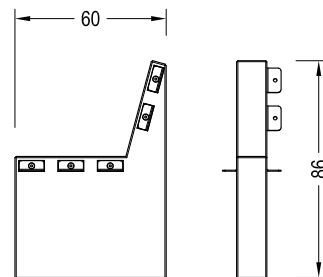
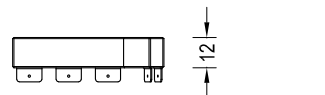

Soporte Banca-Banco 95 kg
Ref. ALPINE-BCA-BCO

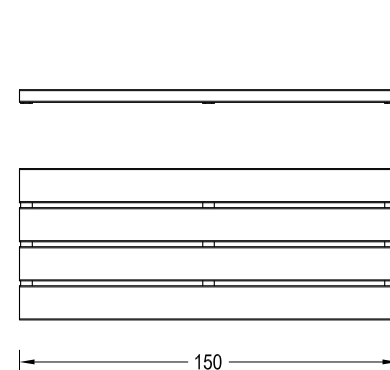
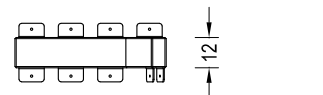

Bastidor Banca 25 kg
Ref. ALPINE-BCA-ACC-150



Disponible en longitud 2150 mm /
Available in length 2150 mm

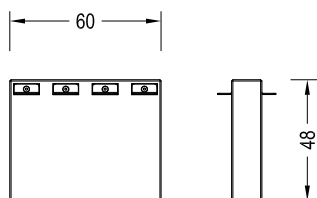

Soporte Banca Doble 83 kg
Ref. ALPINE-BCA-CNT

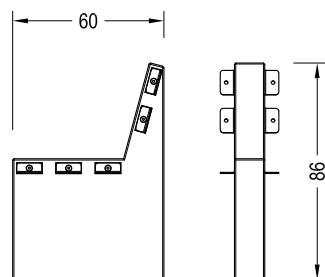
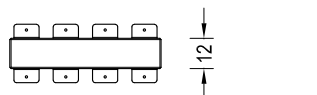

Soporte Banca Doble 95 kg
Ref. ALPINE-BCO-CNT

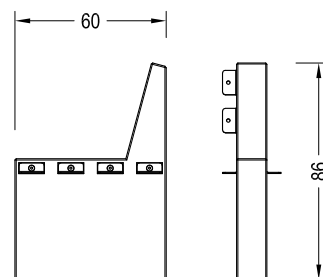
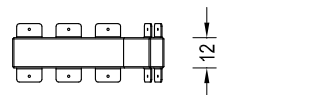

Soporte Banco-Banca 95 kg
Ref. ALPINE-BCO-BCA

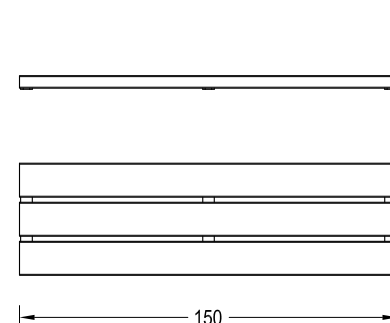
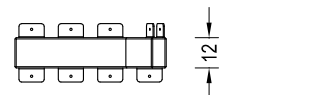

Disponible en longitud 2150 mm /
Available in length 2150 mm

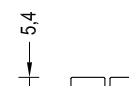
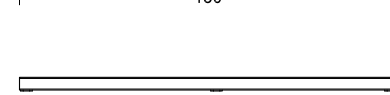

Disponible en longitud 2150 mm /
Available in length 2150 mm

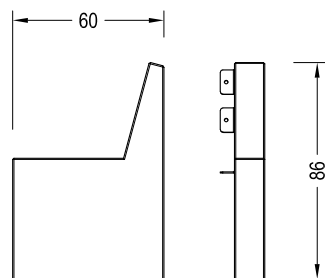

Soporte Banco Izquierdo 95 kg
Ref. ALPINE-BCO-IZQ

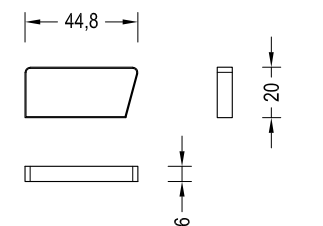
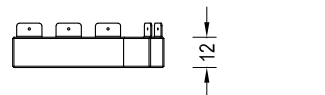

Accesorio Apoyabrazos 2,3 kg
Ref. ALPINE-APOY-ACC

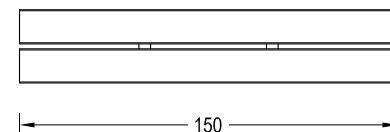

Bastidor Banco 32 kg
Ref. ALPINE-BCO-ACC-150



Ref.ALPIKE-150-01
192 kg

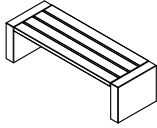

Ref.ALPIKE-150-02
222 kg

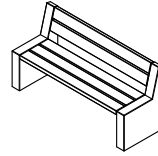

Ref.ALPIKE-150-03
300 kg

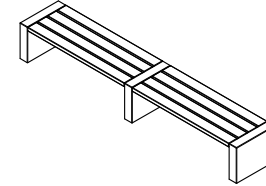

Ref.ALPIKE-150-04
330 kg

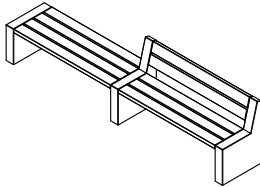

Ref.ALPIKE-150-05
330 kg

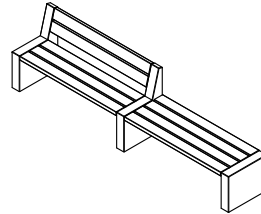

Ref.ALPIKE-150-06
350 kg

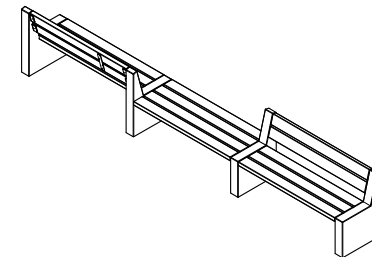
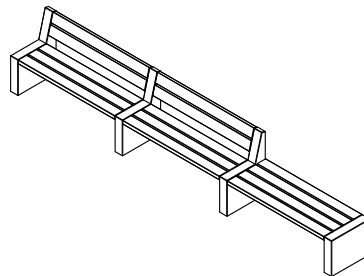
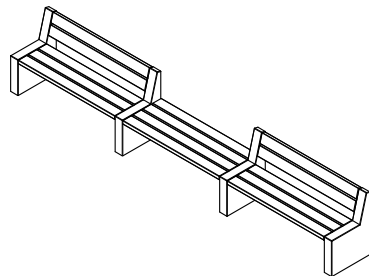
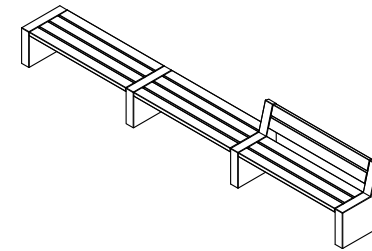
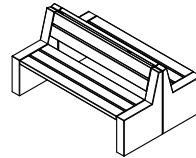
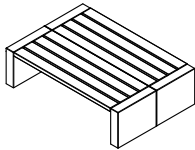
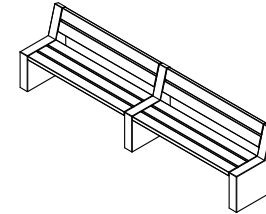

Ref.ALPI-215-01
199 kg

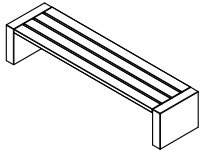

Ref.ALPI-215-02
232 kg

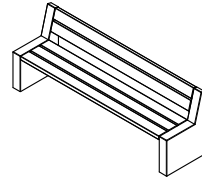

Ref.ALPI-215-03
315 kg

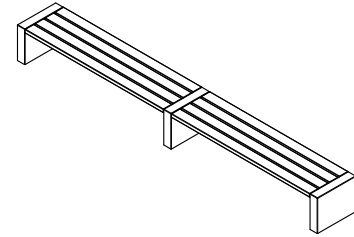

Ref.ALPI-215-04
348 kg

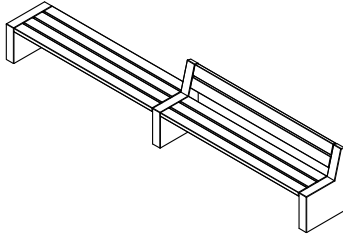

Ref.ALPI-215-05
348 kg

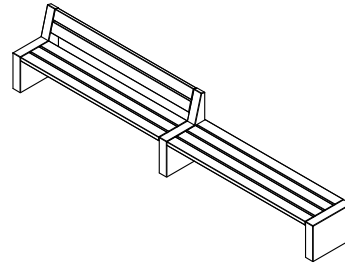

Ref.ALPI-215-06
368 kg

