

# CARACTERISTICAS

**MATERIAL** hormigón  
hormigón armado

**COLOR** blanco / negro / beige

**ACABADO** decapado suave e hidrofugado

**COLOCACION** apoyado sin anclaje

**PESO** banco 1640 kg.  
cubo 510kg.  
respaldo corto 335kg.  
respaldo largo 1135kg.

**PALET** banco 70x260  
cubo 80x80  
respaldo corto 80x80 largo 80x230

**MATERIAL** cast stone  
reinforced cast stone

**COLOUR** white / black / beige

**FINISH** soft acid-treated and waterproofed

**FIXING** free-standing

**WEIGHT** bench 1640 kg.  
cube 510kg.  
short backrest 335kg.  
long backrest 1135kg.

**PALLET** bench 70x260  
cube 80x80  
short backrest 80x80 long 80x230

DISEÑO / DESIGN  
Diego Fortunato

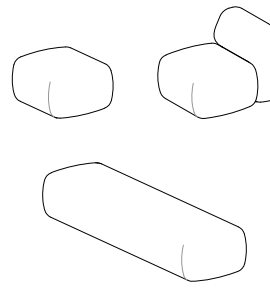

## COLOCACION

## GEOMETRIA

ESCALA 0 CM 50 CM

eslingas de poliéster  
polyester slings

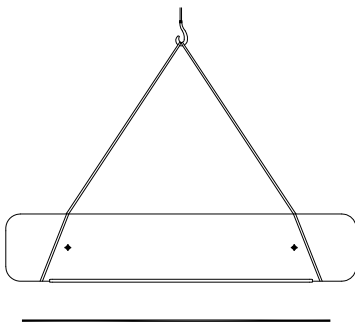

BANCO APOYADO SIN ANCLAJE  
FREE-STANDING BENCH

FIJACION RESPALDO  
FIXING BACKREST

Colocar asiento. Colocar pasador.  
Colocar asiento. Colocar pasador.

∅ 18 pasante  
Varilla roscada M16  
Tuerca M16 inox  
Arandela M16 inox

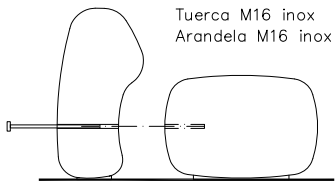

### BANCO SIT

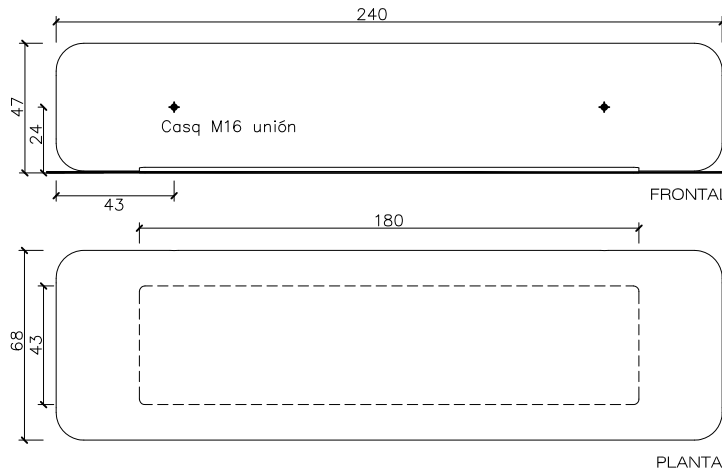

### RESPALDO LARGO

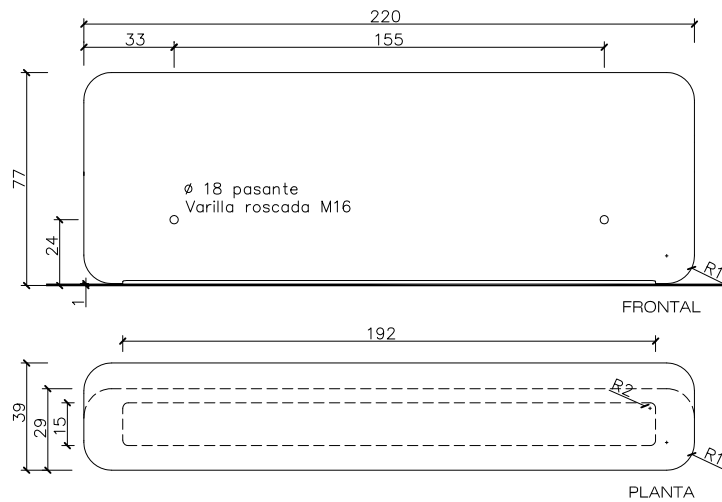

### CUBO SIT

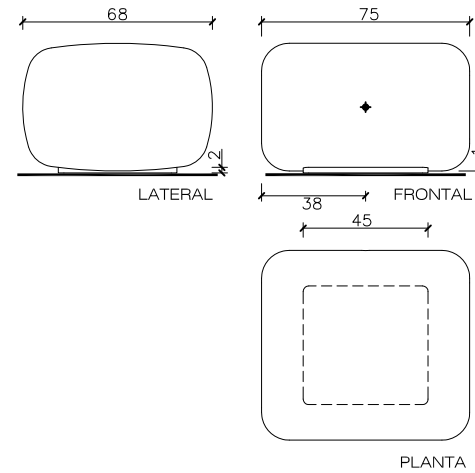

### RESPALDO CORTO

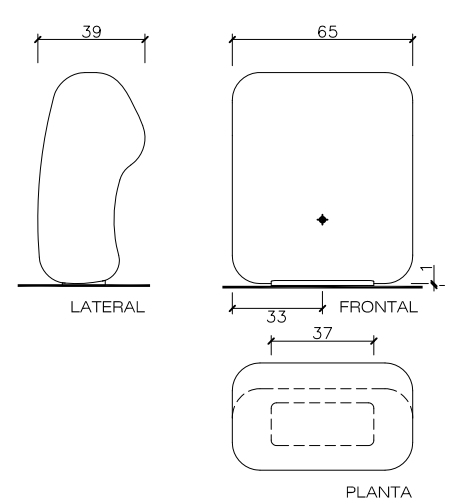

### CUBO CON RESPALDO

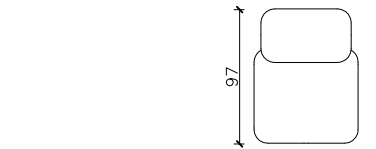
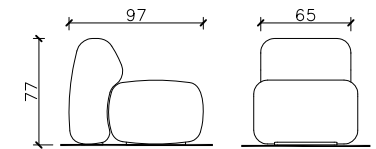

### BANCA CON RESPALDO CORTO

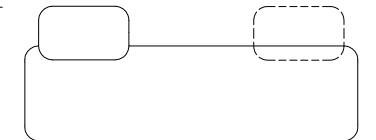
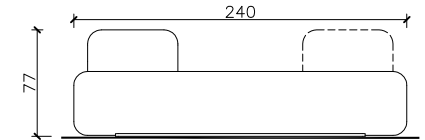

### BANCA CON RESPALDO LARGO

