

## CARACTERISTICAS

MATERIAL polietileno LDPE  
 COLOR blanco  
 ACABADO micro-texturado  
 COLOCACION anclado  
 PESO 40 Kg  
 ILUMINACION 3 perfiles led, 32w  
 color blanco t°5000k

MATERIAL polyethylene LDPE  
 COLOUR white  
 FINISH micro-textured  
 FIXING anchored  
 WEIGHT 40 Kg  
 LIGHTING 3 led strips, 40w  
 white t°5000k

DISEÑO / DESIGN Andreu Arriola / Carme Fiol

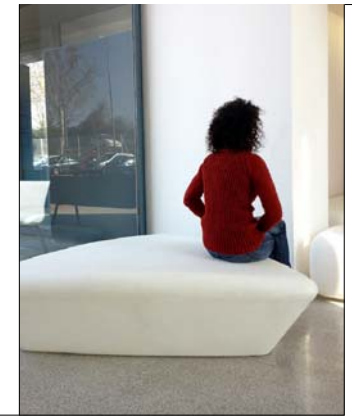
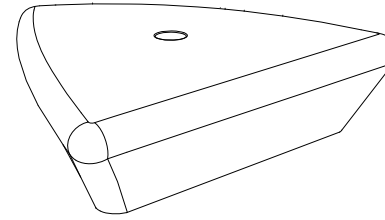

## SISTEMA DE COLOCACION

GEOMETRIA ESCALA 0 CM 500CM

Montaje / mounting

1 INDOOR

Sin anclaje / Free standing

- ① tapa registro roscada  
threaded inspection hatch
- ② acometida eléctrica  
service lead

Elevación / hoisting  
 (P= 40 Kg.)

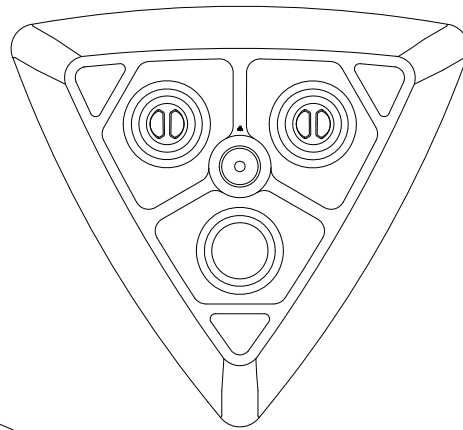

- Lastre de arena opcional para incrementar el peso  
 Optional sand ballast to increase the weight

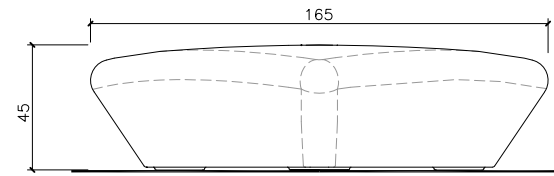
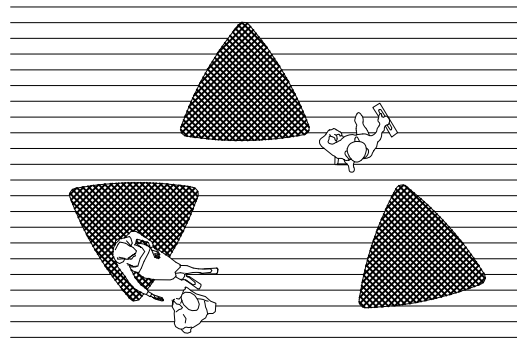
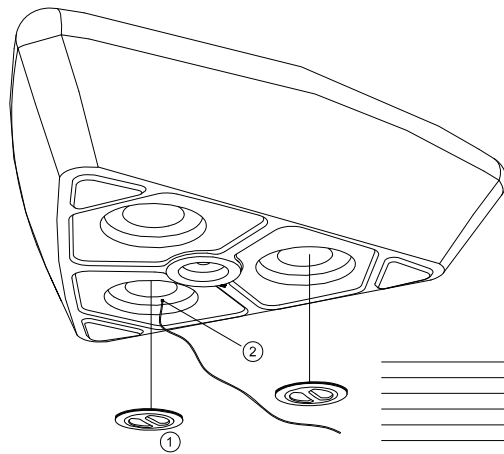

FRONTAL

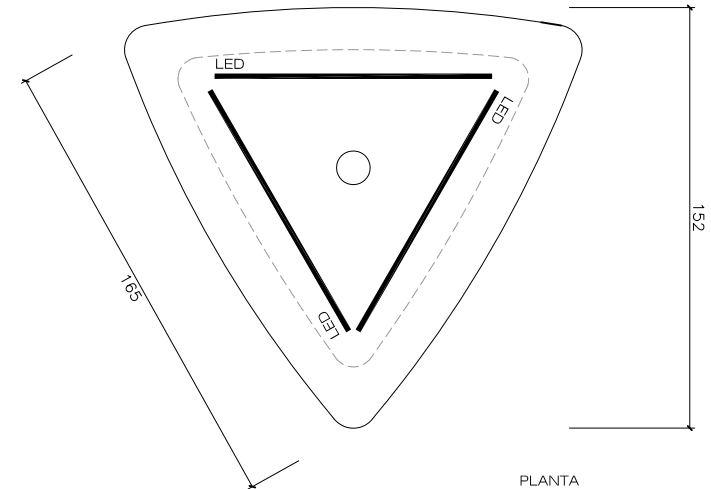

PLANTA