

# CARACTERÍSTICAS / CHARACTERISTICS

**MATERIAL** hormigón / hormigón reciclado *MATERIAL* concrete / recycled concrete  
**COLOR** carta colores estandar *COLOUR* standard color chart  
**ACABADO** decapado e hidrofugado *FINISH* etched and waterproofed  
**COLOC.** anclado con tornillos *FIXING* anchored with screws  
**PESO** G/BORDEAUX: 970kg *WEIGHT* G/BORDEAUX: 970kg  
 G/TOULOUSE: 1230kg G/TOULOUSE: 1230kg  
 G/ARAN: 1410kg G/ARAN: 1410kg

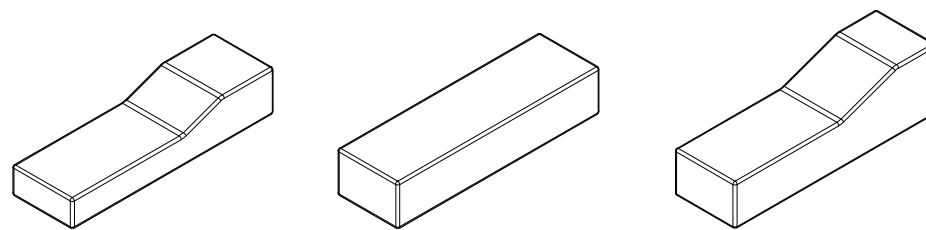

Update 19/07/2018  
 Cotas / Sizes cm

## INSTALACIÓN / INSTALLATION

For all models  
 elevación / hoisting  
 (TOULOUSE P = 1230kg)

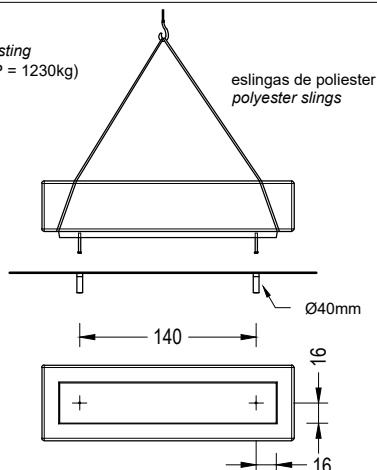

rosacar 2 tornillos a fondo (Din 931 M16 x 140mm)  
 tightly screw 2 stud bolts (Din 931 M16 x 140mm)

taladrar el pavimento y llenar de resina o mortero rico  
 drill pavement fill with resin or fat mortar

EJEMPLO DE AGREGACIONES /  
 AGGREGATION EXAMPLES

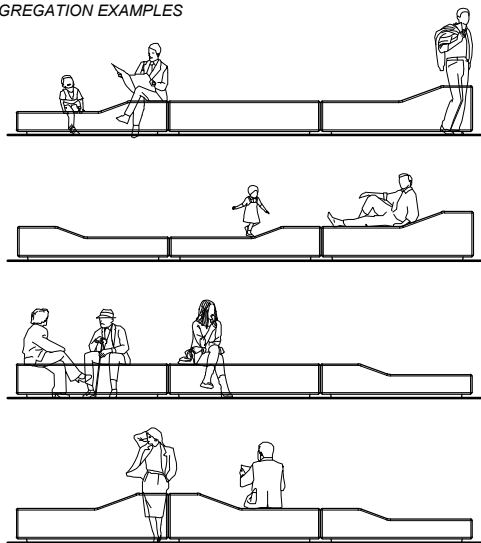

E:1/60

## GEOMETRÍA / GEOMETRY

GARONNE  
 BORDEAUX

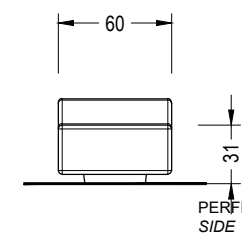
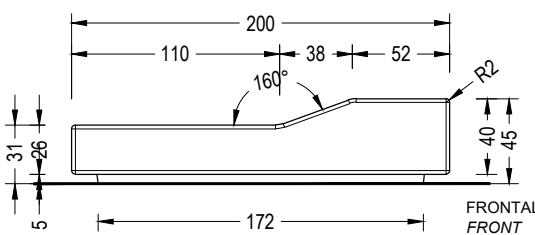
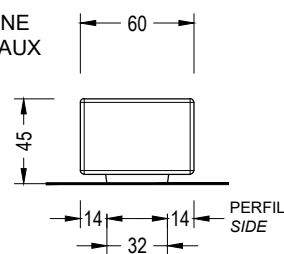

E:1/40

GARONNE  
 TOULOUSE

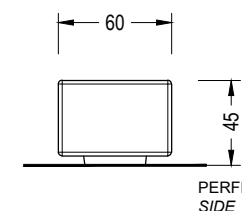
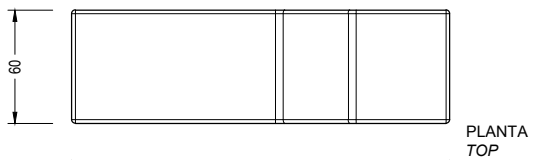
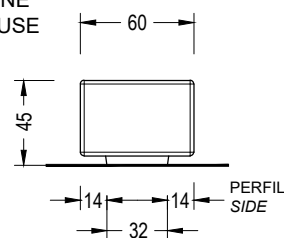

GARONNE  
 ARAN

