

CARACTERÍSTICAS

MATERIAL SOPORTE	madera tropical FSC® acero zincado pintado color negro forja	MATERIAL SUPPORT	tropical wood FSC® zinc plated steel forge black coated finish
COLLOC. PESO	apoyado sin andaje 101 / 152 / 212 / 360 kg	FIXING WEIGHT	free-standing 101 / 152 / 212 / 360 kg

DISENO / DESIGN Joan Gaspar

SISTEMA DE COLOCACIÓN

GEOMETRÍA

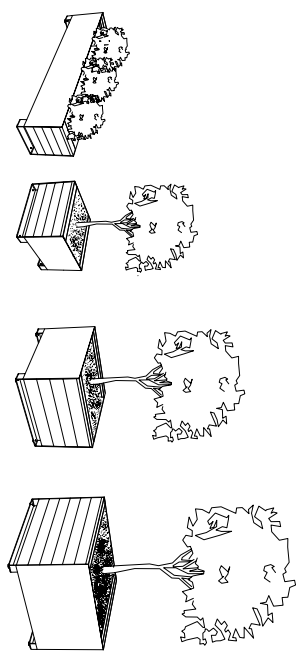

elevación / hoisting
(P= 101 / 152 / 212 / 360 Kg.)

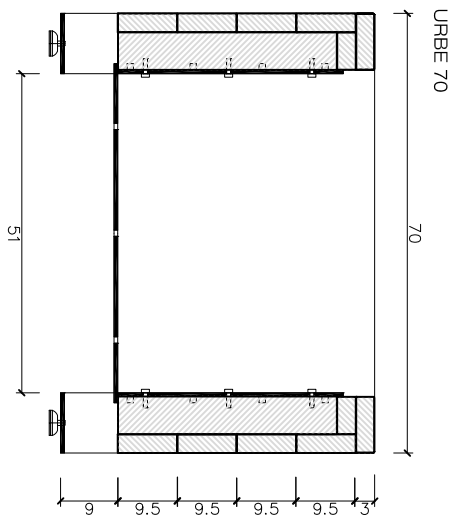
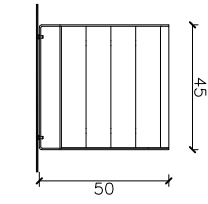
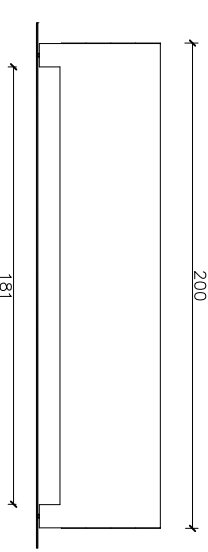
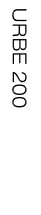
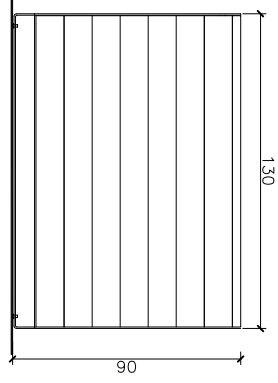
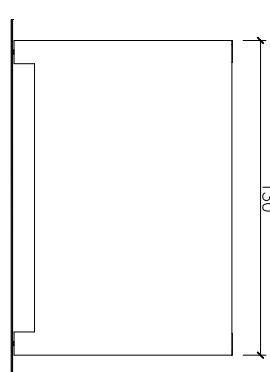
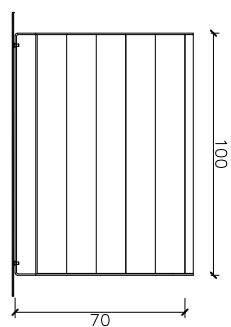
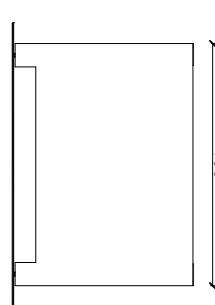
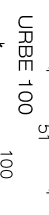
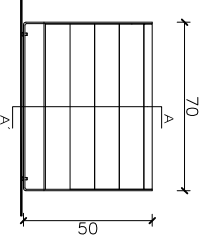
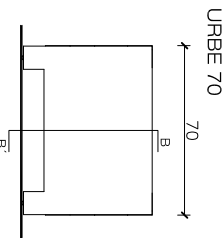
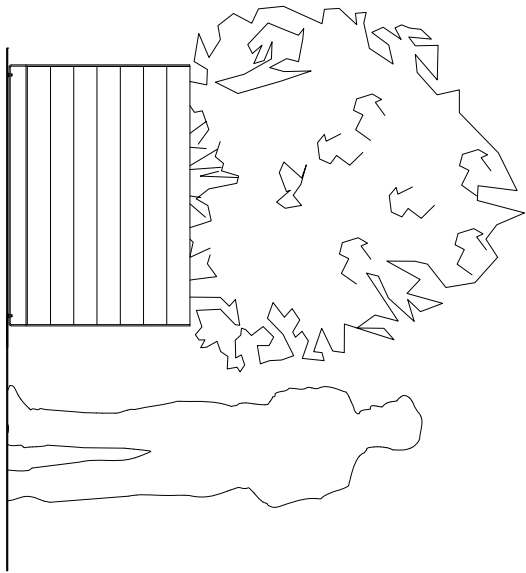
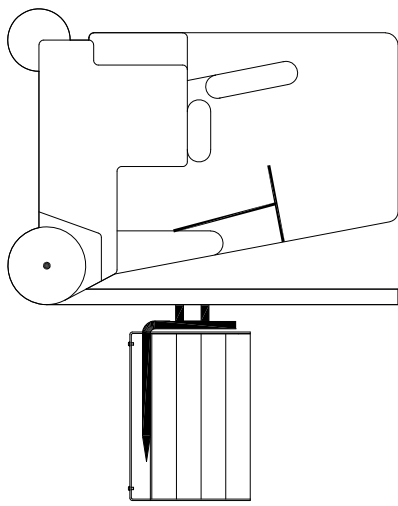

SECCIÓN A-A'

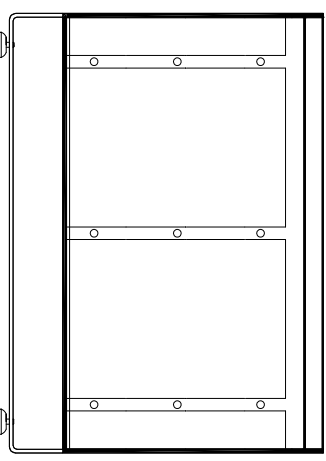

SECCIÓN B-B'