

# CARACTERÍSTICAS / CHARACTERISTICS

MATERIAL	hormigón / hormigón UHPC	MATERIAL	concrete / UHPC concrete
COLOR	carta colores estándar	COLOUR	standard color chart
ACABADO	decapado e hidrofugado	FINISH	etched and waterproofed
COLOC.	apoyado sin anclaje / anclado especial	FIXING	free-standing / anchored with anchor
PESO	Jardinera 2120 kg Tapas 20 / 30 kg	WEIGHT	Planter 2120 kg Lids 20 / 30 kg
CAPACIDAD	A 46 litros / B 38 litros / C 110 litros / D 49 litros / E 43 litros	CAPACITY	A 46 litres / B 38 litres / C 110 litres / D 49 litres / E 43 litres

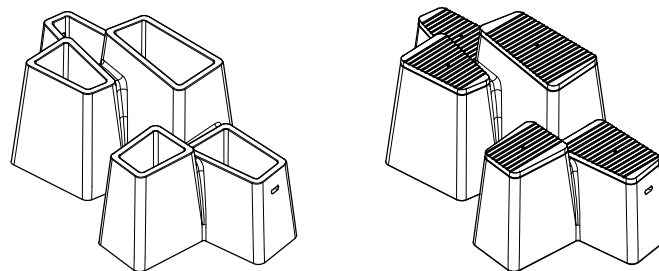

Update 23/10/2020  
Cotas / Sizes cm

## INSTALACIÓN / INSTALLATION

## GEOMETRÍA / GEOMETRY

E:1/60

E:1/30

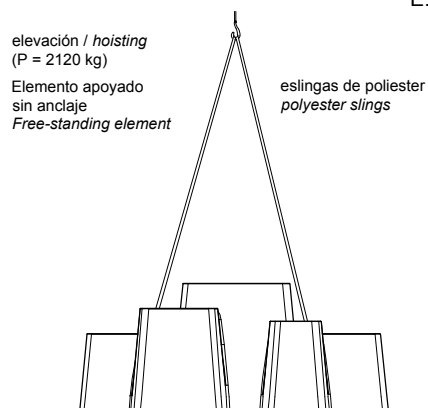

Kit de elevación no incluido en precio del producto  
Lifting kit not included in the product price

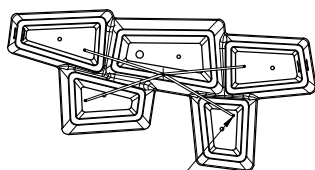

4 cáncamos de elevación M20  
4 Lifting bushes M20

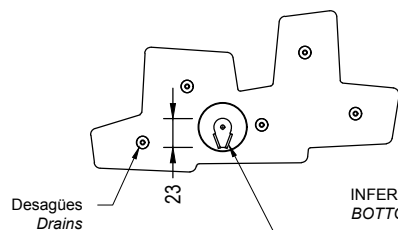

INFERIOR  
BOTTOM

Ancla de fijación suelo  
Floor fixing anchor

SECCIÓN  
SECTION

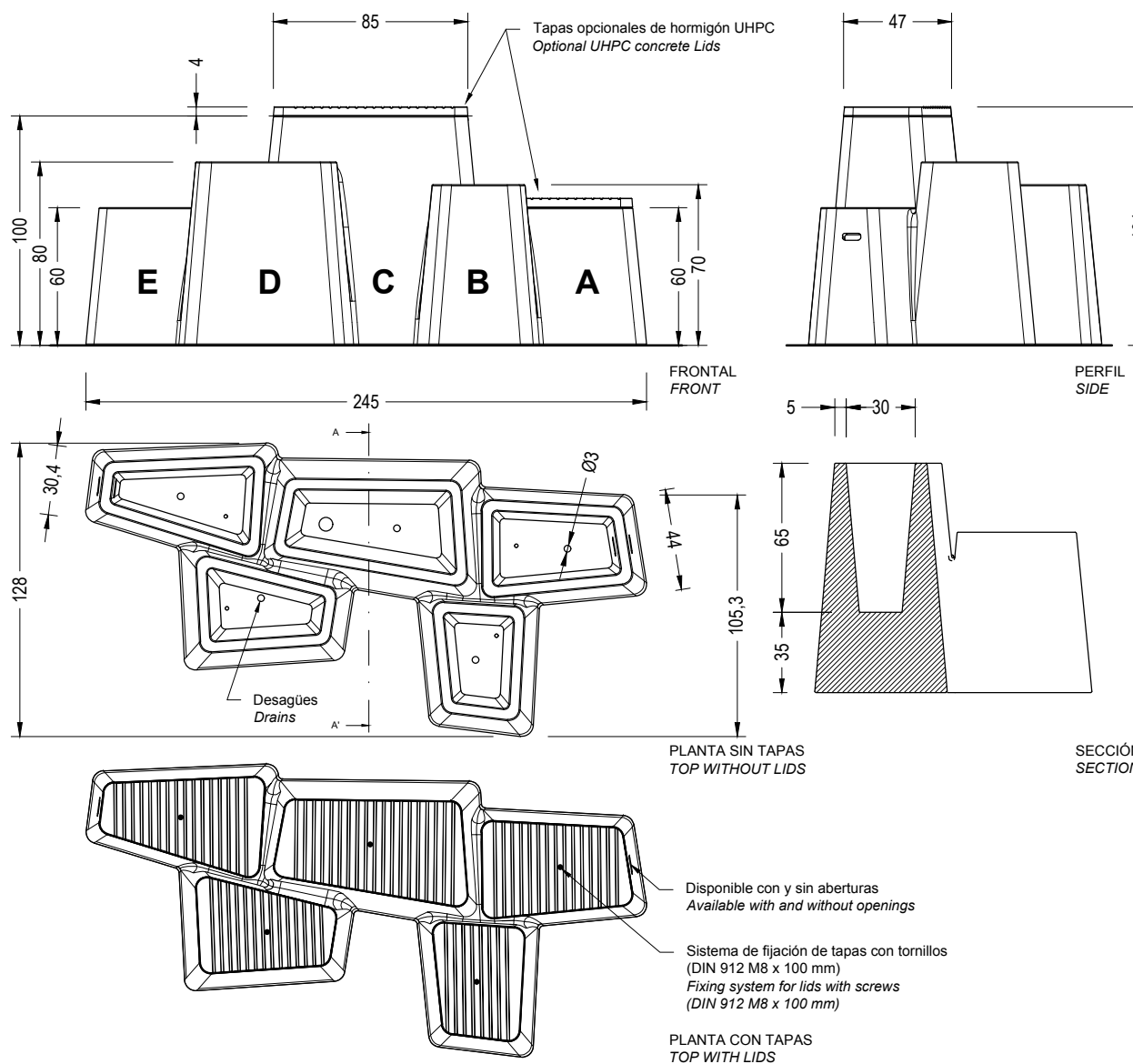

PLANTA SIN TAPAS  
TOP WITHOUT LIDS

SECCIÓN  
SECTION

Disponible con y sin aberturas  
Available with and without openings

Sistema de fijación de tapas con tornillos  
(DIN 912 M8 x 100 mm)  
Fixing system for lids with screws  
(DIN 912 M8 x 100 mm)

PLANTA CON TAPAS  
TOP WITH LIDS

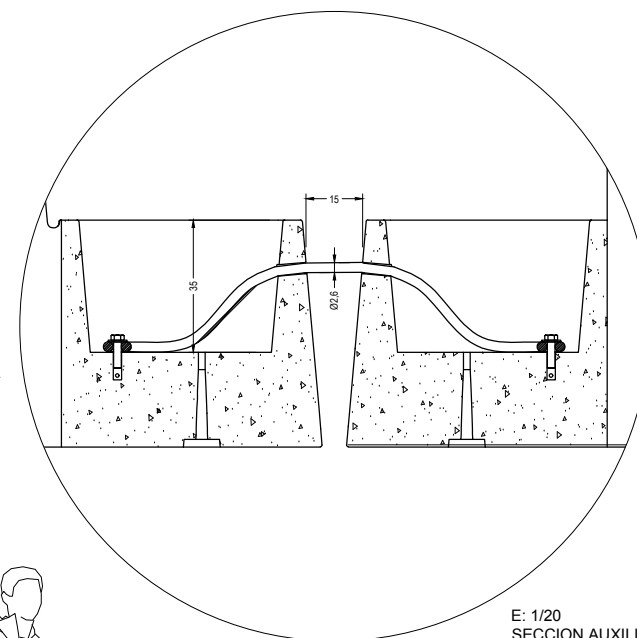
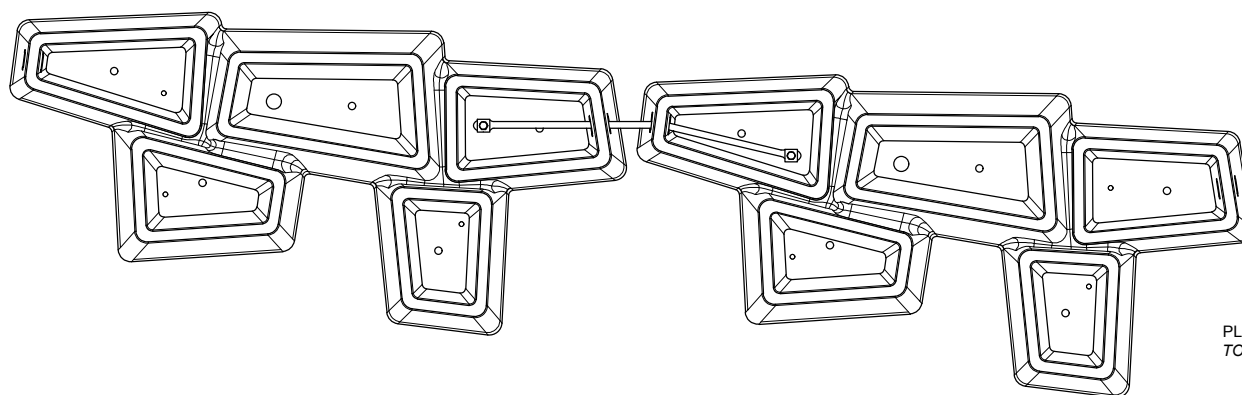
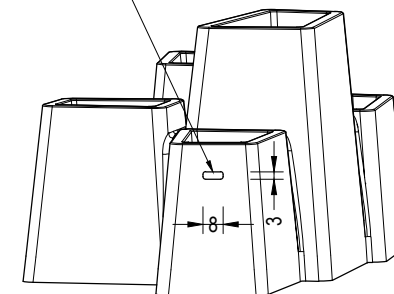
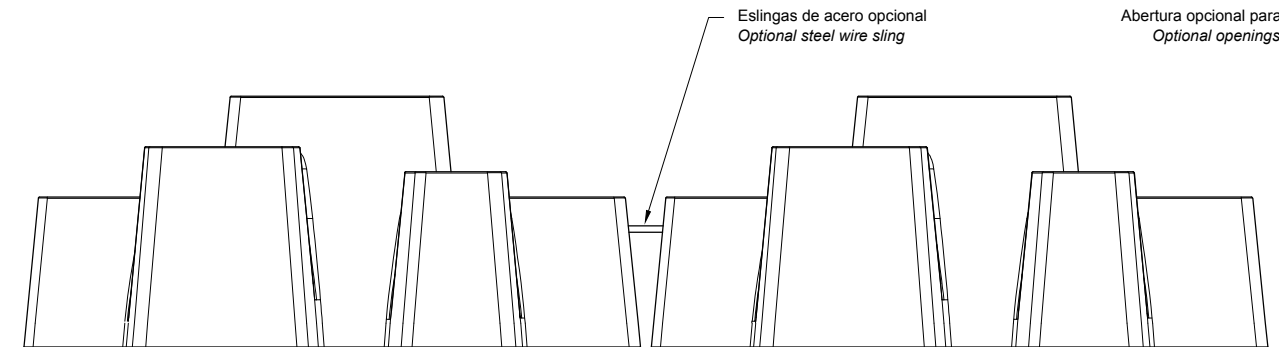

EJEMPLO DE AGREGACIONES /  
AGGREGATION EXAMPLES

