

CARACTERÍSTICAS / CHARACTERISTICS

MATERIAL hormigón / hormigón reciclado
COLOR carta de colores estándar
ACABADO decapado e hidrofugado
COLOC. apoyado sin anclaje
PESO 1075 kg

MATERIAL concrete / recycled concrete
COLOUR standard color chart
FINISH etched and waterproofed
FIXING free-standing
WEIGHT 1075 kg

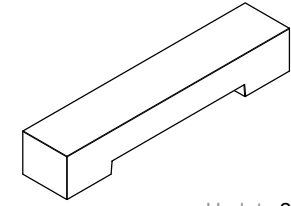

Update 27/01/2020
 Cotas / Sizes cm

INSTALACIÓN / INSTALATION

E:1/60

elevación / hoisting
 P = 1075 kg

banca apoyada sin
 anclajes / free-standing
 backless bench

elevación con eslingas
 de poliéster / hoisting
 with polyester slings

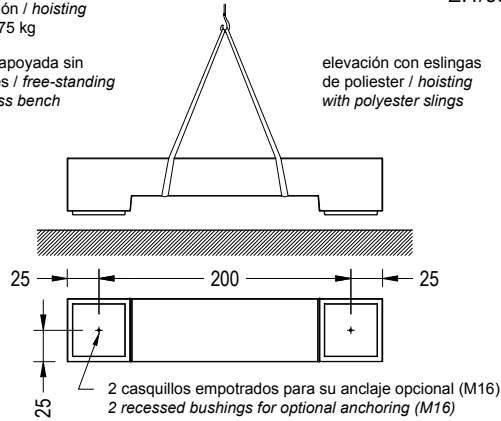

descarga con carretilla elevadora
 unloading by fork-lift

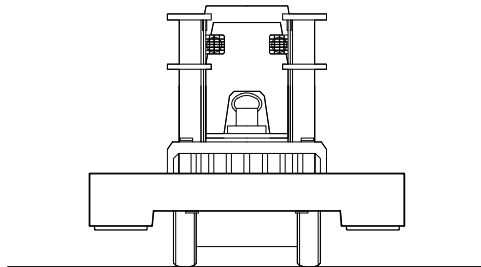

FRONTAL
 FRONT

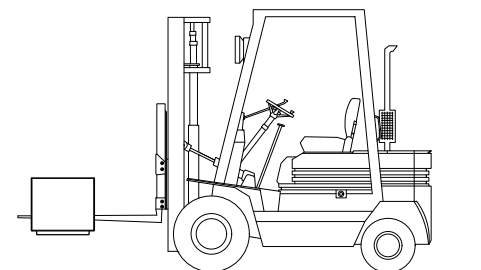

LATERAL
 SIDE

GEOMETRÍA / GEOMETRY

E:1/20

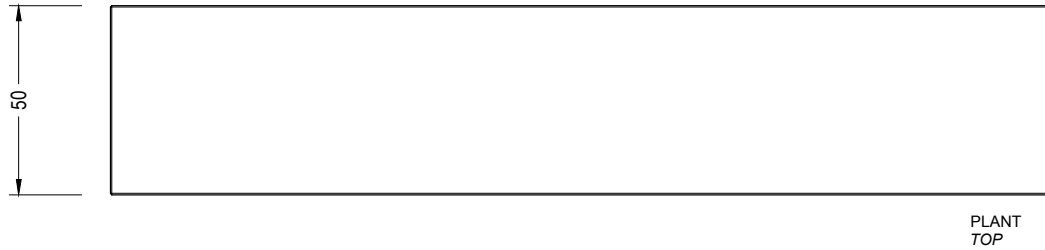
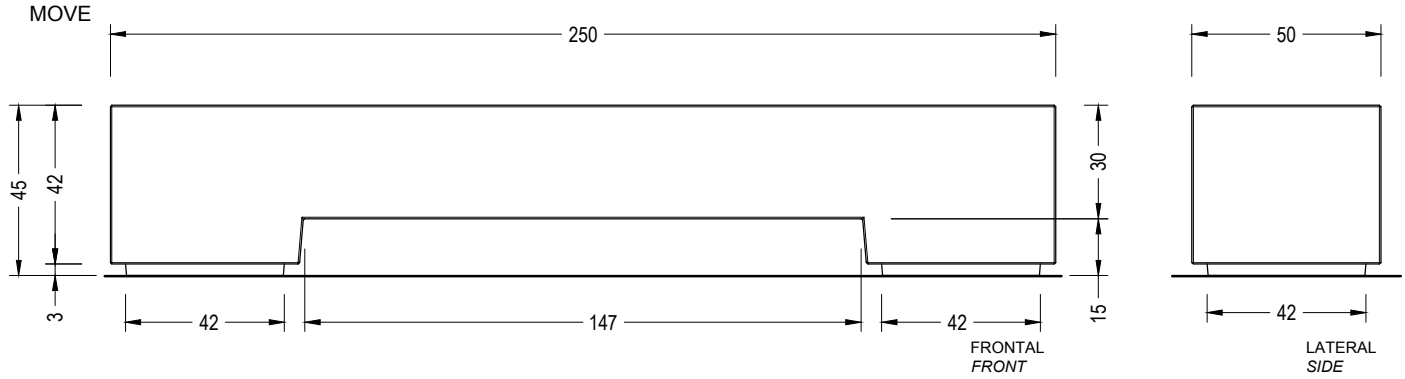

AGREGACIÓN / AGGREGATION

E:1/40

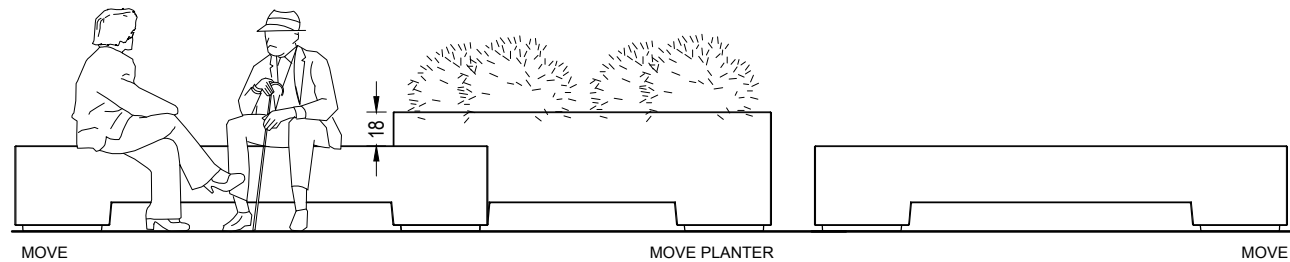

CARACTERÍSTICAS / CHARACTERISTICS

MATERIAL hormigón / hormigón reciclado
 COLOR carta de colores estándar
 ACABADO decapado e hidrofugado
 COLOC. apoyado sin anclaje
 PESO 875 kg
 CAPACIDAD 300 litros

MATERIAL concrete / recycled concrete
 COLOUR standard color chart
 FINISH etched and waterproofed
 FIXING free-standing
 WEIGHT 875 kg
 CAPACITY 300 litres

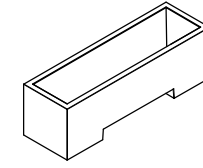

Update 27/01/2020
 Cotas / Sizes cm

INSTALACIÓN / INSTALLATION

E:1/60

elevación / hoisting
 (P = 875 kg)

elevación con tierra /
 weight with soil
 (P = 1385 kg)

elevación con eslingas
 de poliéster / hoisting
 with polyester slings

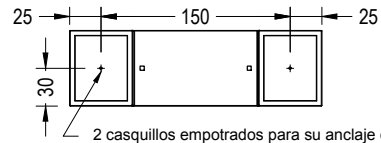
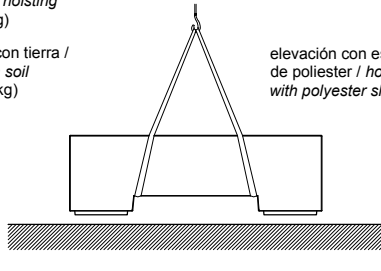

2 casquillos empotrados para su anclaje opcional (M16)
 2 recessed bushings for optional anchoring (M16)

descarga con carretilla elevadora
 unloading by fork-lift

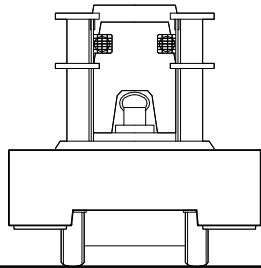

FRONTAL
 FRONT

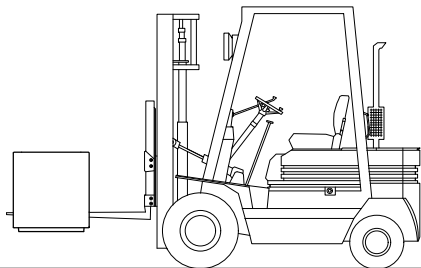

LATERAL
 SIDE

GEOMETRÍA / GEOMETRY

E:1/30

MOVE PLANTER

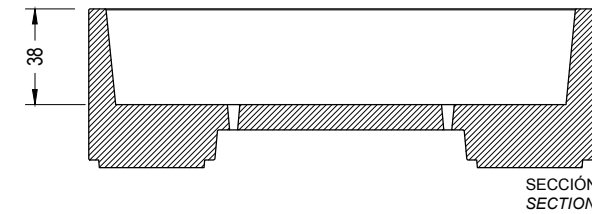
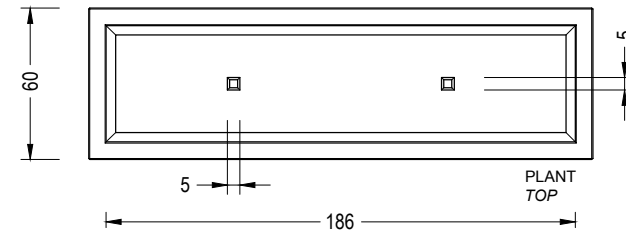
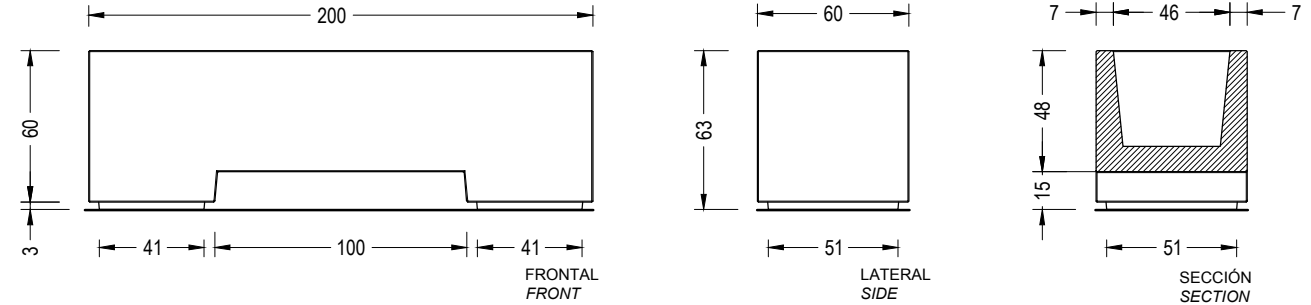

AGREGACIÓN / AGGREGATION

E:1/40

