





Le banc modulaire *Comú*, moulé en béton, répond au besoin de créer un lieu de rencontre. Sa configuration basique circulaire d'un diamètre extérieur de 4 mètres et fermé sur lui-même, invite à se réunir pour des durées prolongées, aussi bien en intérieur qu'en extérieur. L'éclairage LED intégré sous le siège prolonge son utilisation le soir.

Béton | Modulaire |  195 cm/max. |  830 kg |  3

Option(s):  |  | LED

 Update 11.03.2021



Origine

Comú, avec sa forme originale, composée de cercles à trois modules concaves, a été créé pour la Rambla Sant Francesc, un vaste espace civique polyvalent du centre de la ville catalane de Vilafranca del Penedès, qui recouvre et achève la construction d'un parking souterrain. Les arbres qui lui apportaient son identité ont dû être coupés à cet effet.

Modulaire

Son aspect modulaire et la combinaison de modules droits, concaves et convexes, permet une infinité de présentations, s'adaptant à toutes sortes d'espaces.

Matériel

Béton moulé et finition décapée. Il est fabriqué dans tous les coloris du nuancier standard *Escofet*. Tous les modules disposent d'une régale pour la plaque de lampe LED ainsi que d'un espace pour le driver. Dossier en tôle perforée d'acier zingué peinture couleur argent texturé pour les modules droits et concaves. Accessoire d'accoudoir composé du même matériau et de la même finition.

Installation

Les modèles de la série *Comú* sont disponibles en trois versions : concave, convexe et droit. Ils sont fixés au sol par deux tiges métalliques filetées M16 x 140 mm.



COMÚ



Escofet®

1. Banc modulaire

Comú Recto	Derecha	Central	Izquierda	Individual
Dimensions	195 x 48 x 50 cm	195 x 48 x 50 cm	195 x 48 x 50 cm	195 x 48 x 50 cm
Poids	830 kg	815 kg	830 kg	865 kg
Comú Concavo				
Dimensions	195 x 67 x 50 cm	195 x 67 x 50 cm	195 x 67 x 50 cm	195 x 67 x 50 cm
Poids	830 kg	815 kg	830 kg	865 kg
Comú Convexo				
Dimensions	195 x 67 x 50 cm	195 x 67 x 50 cm	195 x 67 x 50 cm	195 x 67 x 50 cm
Poids	830 kg	815 kg	830 kg	865 kg
Illumination	Bande LED 8 W/m; 3000°K / 6000°K			
Driver	24 V / 1,5A / IP67			

1.1 Caractéristiques générales

Matériel	Béton	Pose	Fixation avec vis
Finition	Sablé et hydrofugé		
Dossier et accoudoirs	Acier zingué		
Finition	Peinture couleur argent texturé avec protection contre la corrosion pour une catégorie de corrosivité atmosphérique C5 selon la norme UNE-EN ISO 12944-2.		

Couleurs

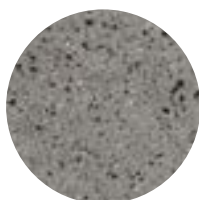

GR. Gris



NG. Noir

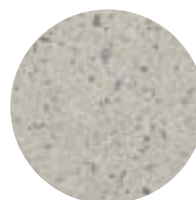

BL. Blanc

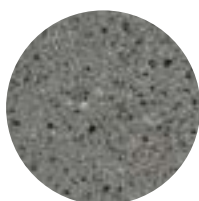

CA. Gris CA



RA. Rouge

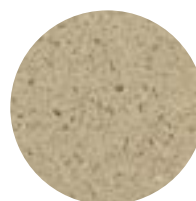

BG. Beige

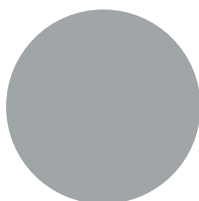

A. Acier argent texturé

1.2 Système de pose

Élévation

(P= 815 / 830 / 865 kg)

Installation

Percer le trottoir avec un foret de $\text{Ø}40 \times 180$ mm. Remplir de résine ou de mortier riche. Visser les 2 vis profondes M16x140. Centrez, placez le banc et réassemblez la zone de support.

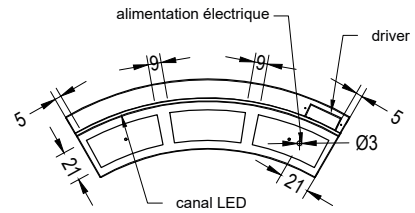
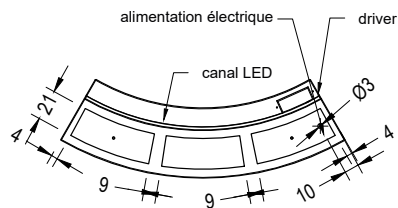
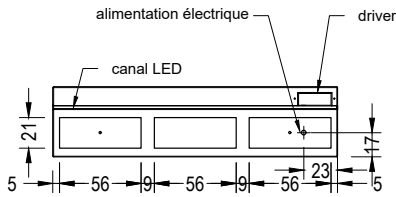
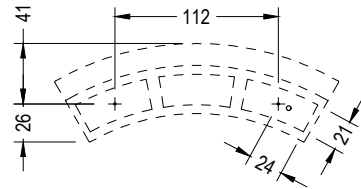
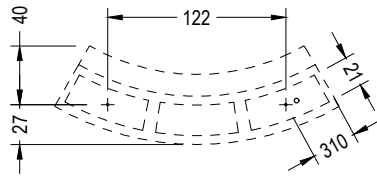
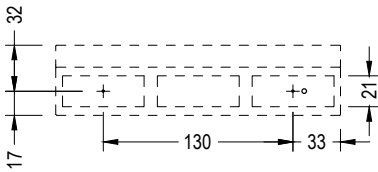
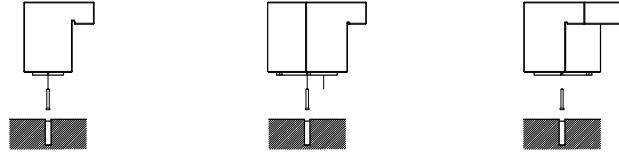
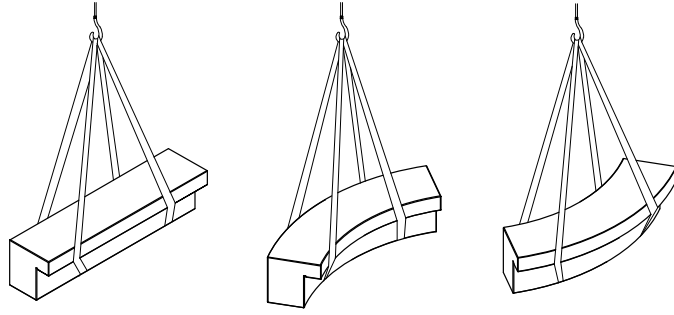

1.3. Éclairage

LED	
Tension de service	24V
Puissance	8W/m
Température de couleur	6000K
Degré de protection	IP67

Driver Vossloh ou similaire	
Puissance	30W
Voltage	220-240V
Fréquence	50-60Hz
Facteur de puissance	>0,9
Degré de protection	IP67

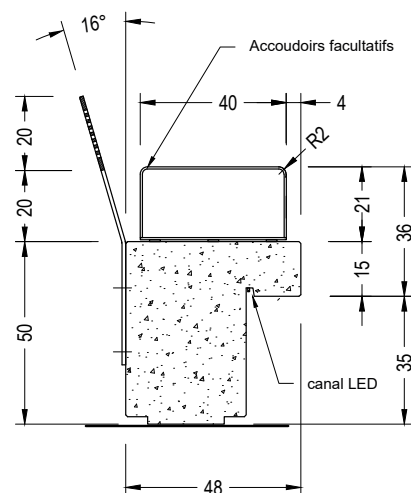

1.4. Géométrie Recto

Comú Recto Central

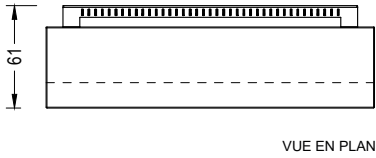
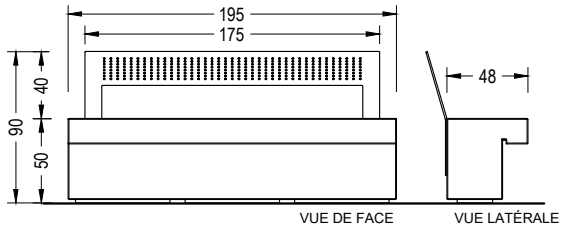

Comú Recto Derecho

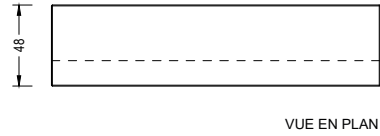
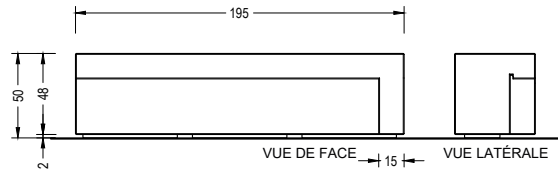

Comú Recto Individual

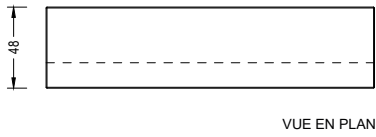
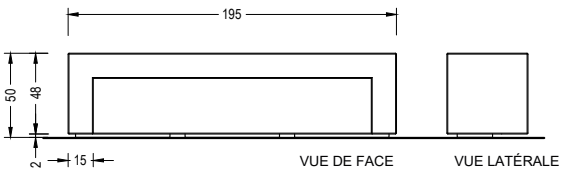

Comú Recto Izquierdo

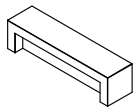
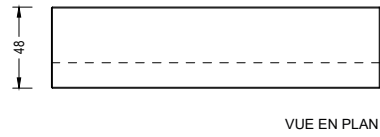
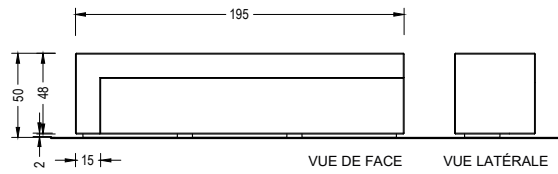

COMU RECTO INDIVIDUAL

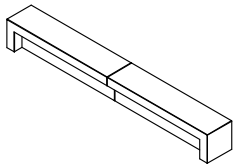

COMU RECTO DUPLO

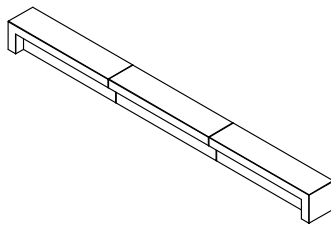

COMU RECTO LINE

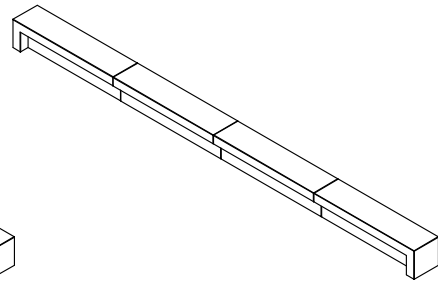

COMU RECTO LINE
+ 1 COMU EXTENSION (RECTO CENTRAL)

COMÚ

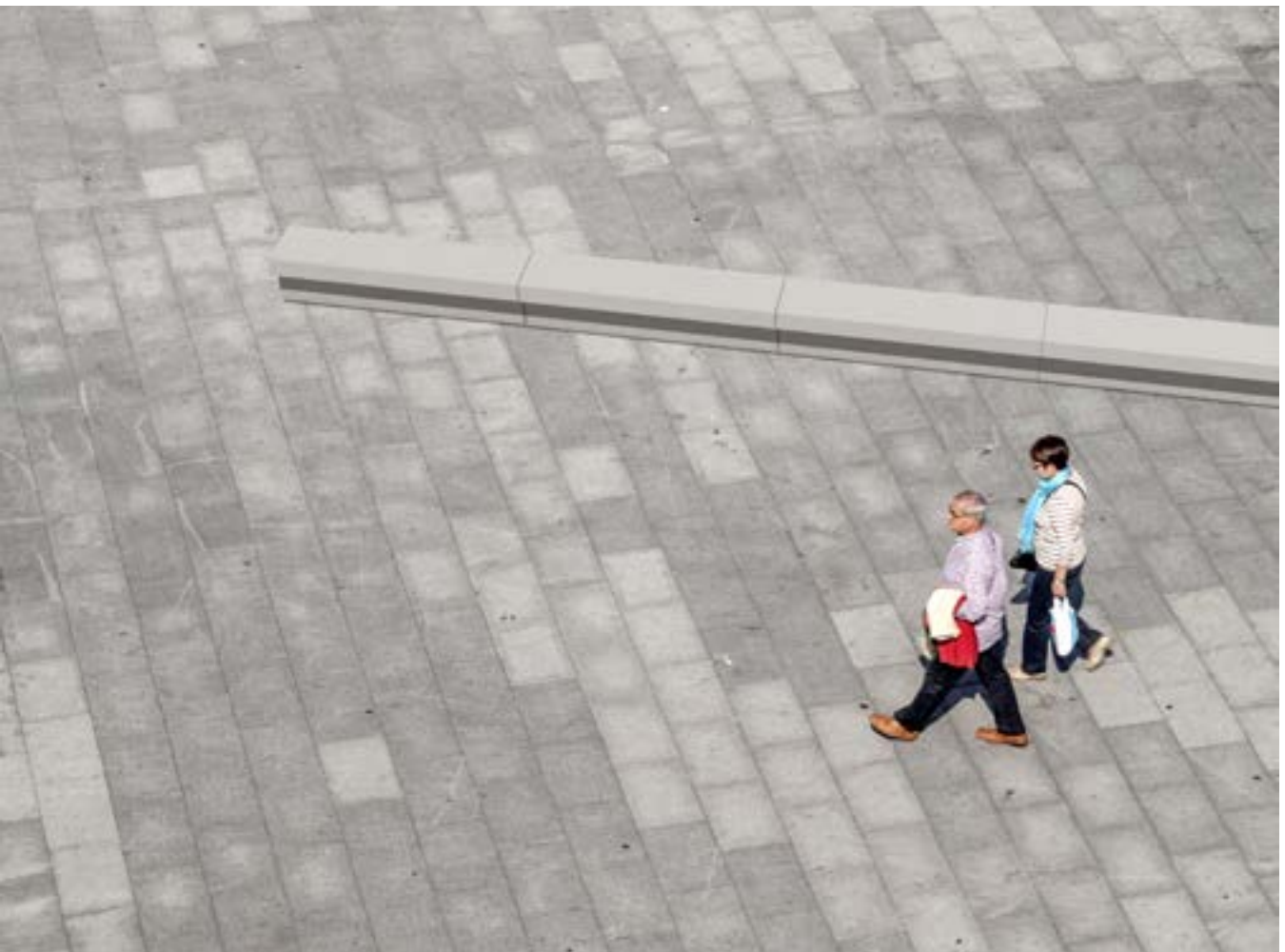

Escofet®

1.5. Geometría Cóncavo-Convexo

Comú Cóncavo Central

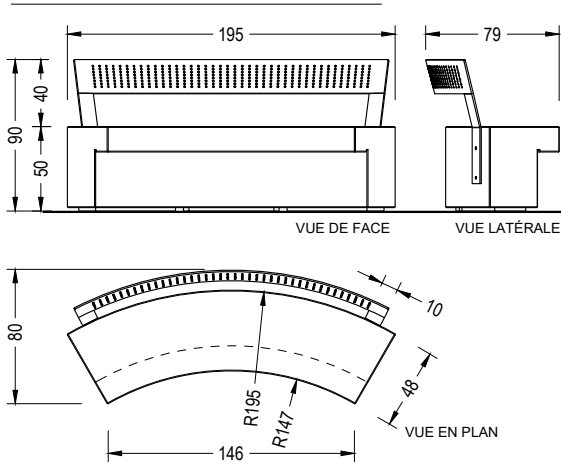

Comú Cóncavo Derecho

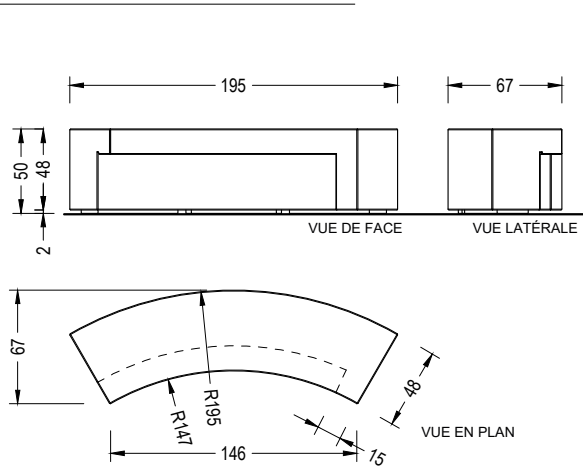

Comú Cóncavo Individual

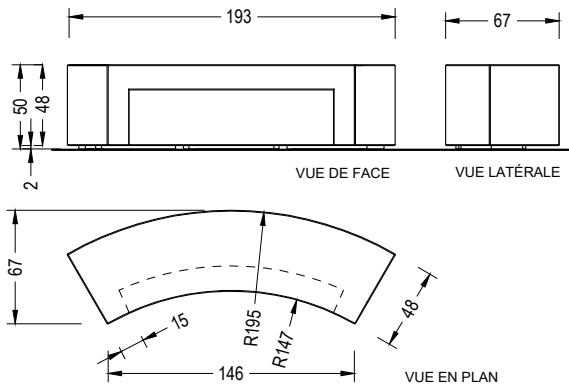

Comú Cóncavo Izquierdo

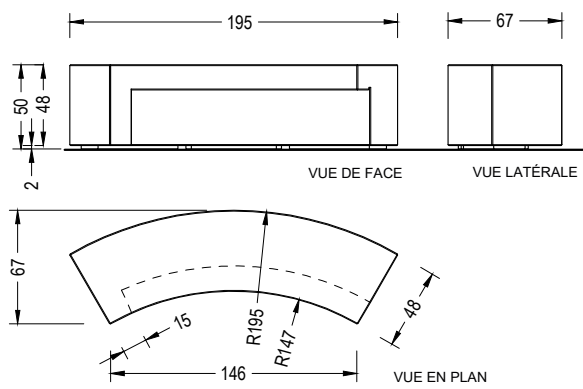

Comú Convexo Central

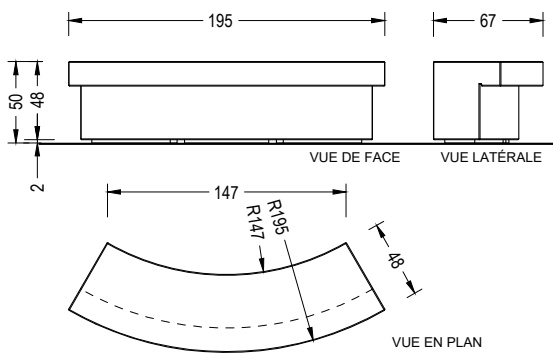

Comú Convexo Derecho

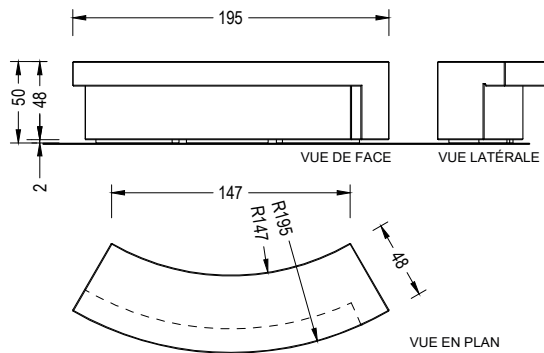

Comú Convexo Individual

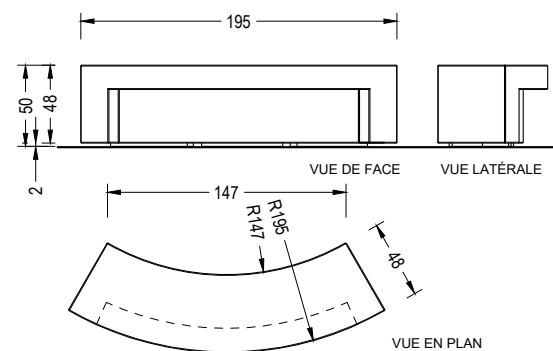

Comú Convexo Izquierdo

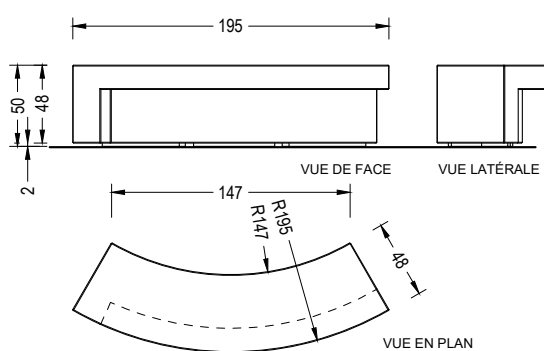

1.6. Agregaciones

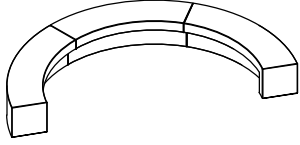

1 COMÚ CÓNCAVO CENTRAL +
1 COMÚ CÓNCAVO DERECHO +
1 COMÚ CÓNCAVO IZQUIERDO

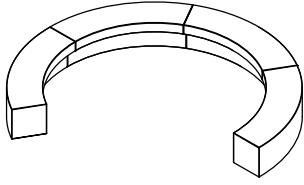

2 COMÚ CÓNCAVO CENTRAL +
1 COMÚ CÓNCAVO DERECHO +
1 COMÚ CÓNCAVO IZQUIERDO

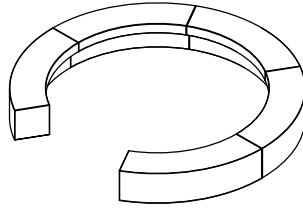

3 COMÚ CÓNCAVO CENTRAL +
1 COMÚ CÓNCAVO DERECHO +
1 COMÚ CÓNCAVO IZQUIERDO

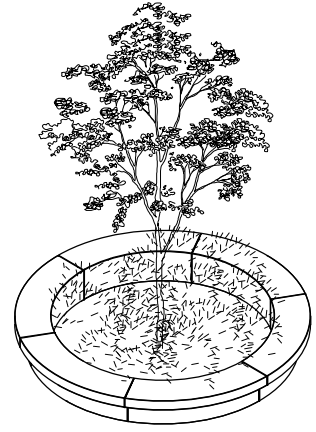

6 COMÚ CONVEXO

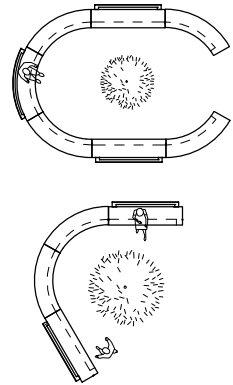
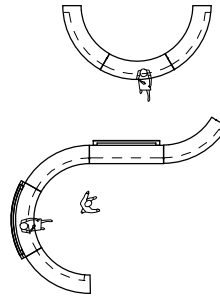
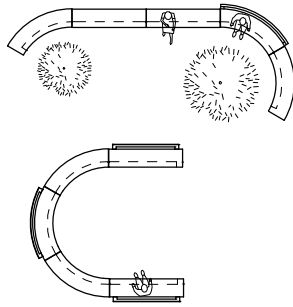
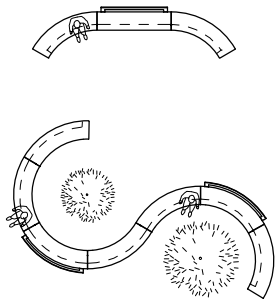

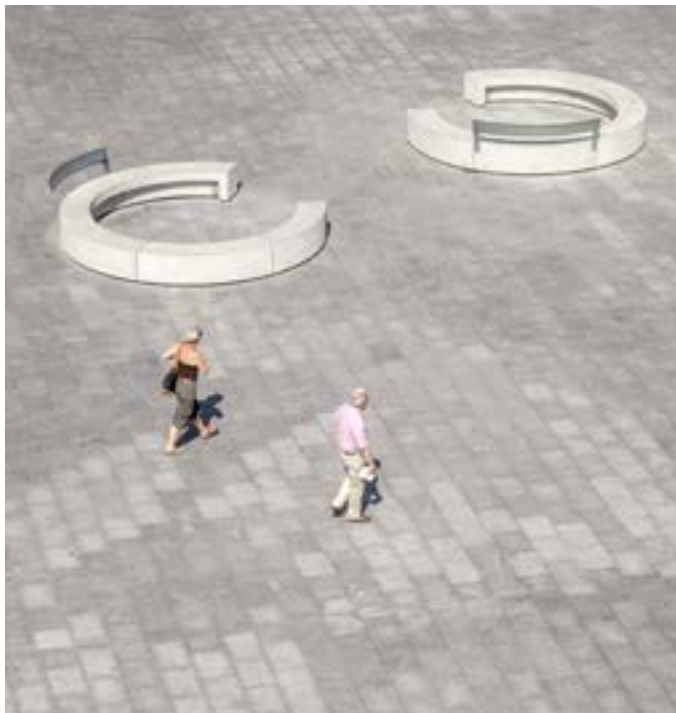

Garantie

5 années sur les composants de béton.

Les noms, marques et modèles industriels des produits ont été déposés au registre correspondant. Les informations techniques de ce document peuvent être modifiées sans préavis.

Escofet 1886 S.A
Siège et production

Montserrat, 162
E 08760 Martorell
Barcelona - España
T. 0034 937 737 150
F. 0034 937 737 151

info@escofet.com
www.escofet.com

