

# CARACTERÍSTICAS / CHARACTERISTICS

**MATERIAL** hormigón  
 pino nórdico FSC®  
**COLOR** carta de colores estándar  
**ACABADO** decapado e hidrofugado  
 protección al autoclave  
**SOPORTES** acero zincado  
**ACABADO** pintado color plata texturizado  
**COLOC.** apoyado sin anclaje  
**PESO** 1200 kg / 1225 kg / 1420 kg

**MATERIAL** concrete  
 nordic pine wood FSC®  
**COLOUR** standard colour chart  
**FINISH** etched and waterproofed  
 high-pressure protected  
**SUPPORTS** zinc plated steel  
**FINISH** textured silver coated finish  
**FIXING** free-standing  
**WEIGHT** 1200 kg / 1225 kg / 1420 kg

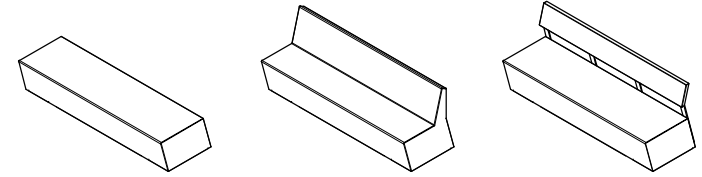

Update 09/02/2021  
 Cotas / Sizes cm

## INSTALACIÓN / INSTALLATION

elevación / hoisting  
 P = 1200 kg / 1420 kg

eslingas de poliéster /  
 polyester slings

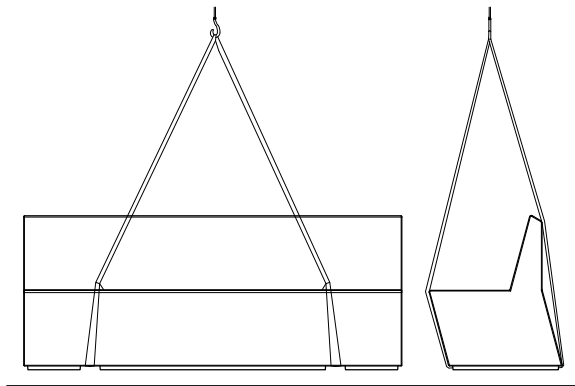
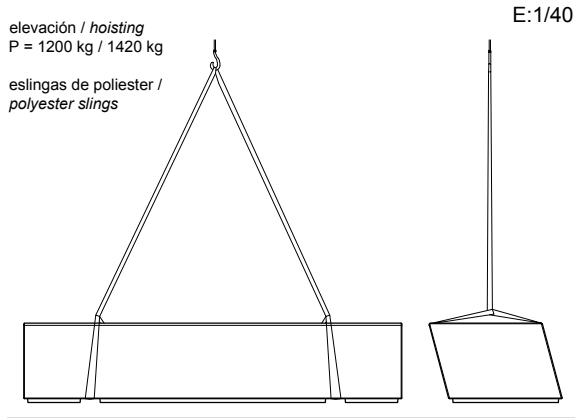

banco apoyado sin anclaje  
 free-standing bench

## AGREGACIÓN / AGGREGATION

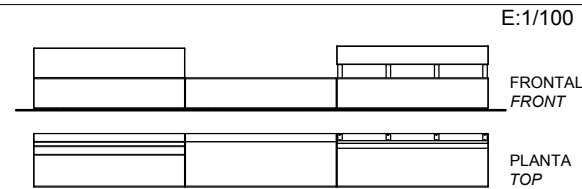

banco hormigón  
 concret bench     
 banca  
 backless bench     
 banca + respaldo madera  
 backless bench + wood back

## GEOMETRÍA / GEOMETRY

ZUERA banca / backless bench

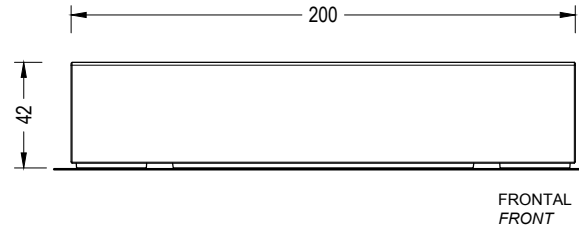

FRONTAL  
 FRONT

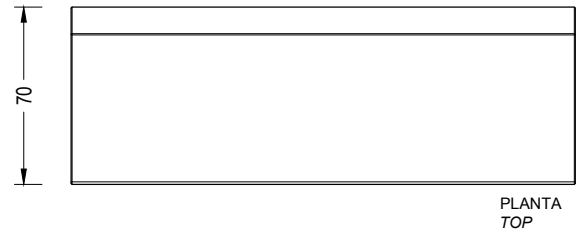

PLANTA  
 TOP

ZUERA banco hormigón / concret bench

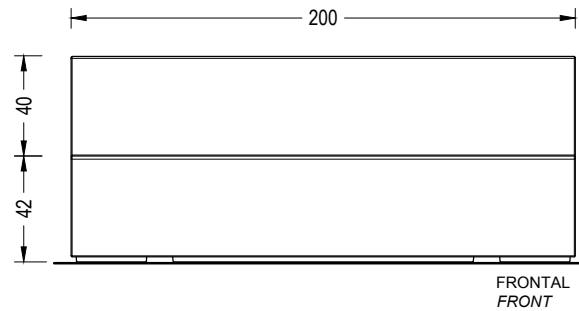

FRONTAL  
 FRONT

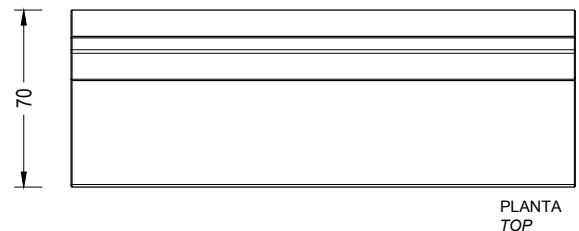

PLANTA  
 TOP

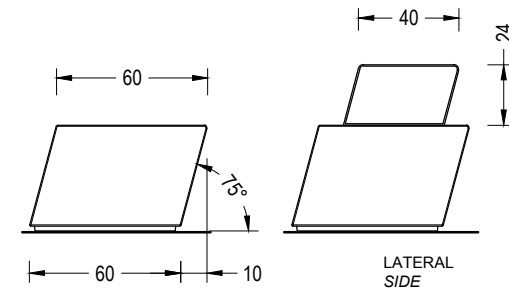

LATERAL  
 SIDE

Opcional con o sin reposabrazos  
 Optional with or without armrest

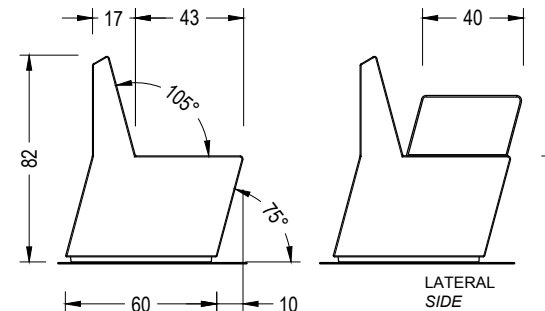

LATERAL  
 SIDE

Opcional con o sin reposabrazos  
 Optional with or without armrest

# CARACTERÍSTICAS / CHARACTERISTICS

**MATERIAL** hormigón  
 pino nórdico FSC®  
**COLOR** carta de colores estándar  
**ACABADO** decapado e hidrofugado  
 protección al autoclave  
**SOPORTES** acero zincado  
**ACABADO** pintado color plata texturizado  
**COLOC.** apoyado sin anclaje  
**PESO** 1200 kg / 1225 kg / 1420 kg

**MATERIAL** concrete  
 nordic pine wood FSC®  
**COLOUR** standard colour chart  
**FINISH** etched and waterproofed  
 high-pressure protected  
**SUPPORTS** zinc plated steel  
**FINISH** textured silver coated finish  
**FIXING** free-standing  
**WEIGHT** 1200 kg / 1225 kg / 1420 kg

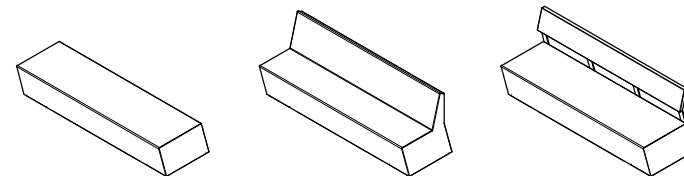

Update 09/02/2021  
 Cotas / Sizes cm

## INSTALACIÓN / INSTALLATION

elevación / hoisting  
 P = 1225 kg

eslingas de poliéster /  
 polyester slings

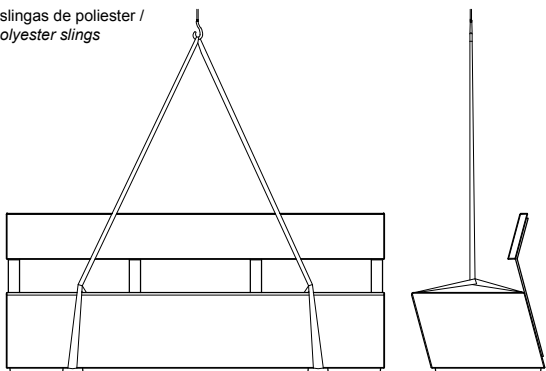

banco apoyado sin anclaje  
 free-standing bench

E:1/40

## AGREGACIÓN / AGGREGATION

E:1/100

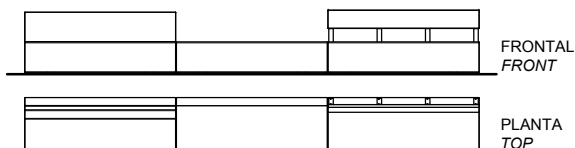

banco hormigón  
 concret bench      banca  
 backless bench      banca + respaldo madera  
 backless bench + wood back

## GEOMETRÍA / GEOMETRY

E:1/30

ZUERA banca con respaldo madera / backless bench with wood back

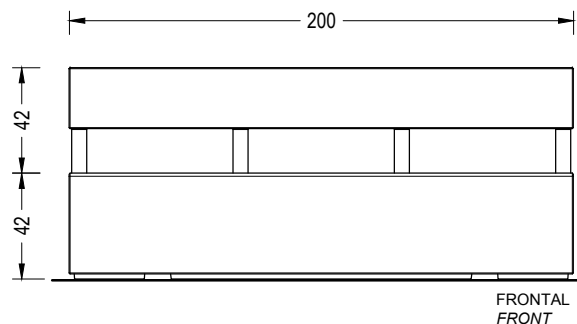

FRONTAL  
 FRONT

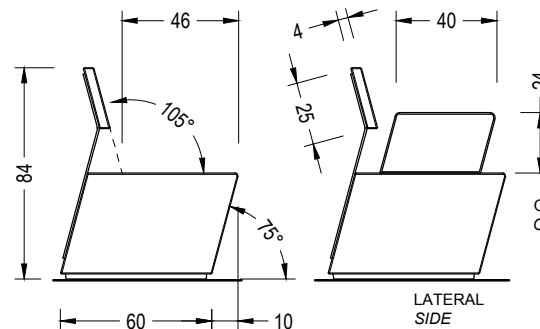

LATERAL  
 SIDE

Opcional con o sin reposabrazos  
 Optional with or without armrest

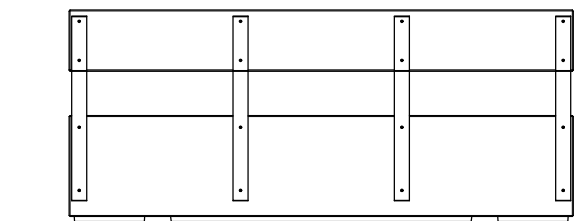
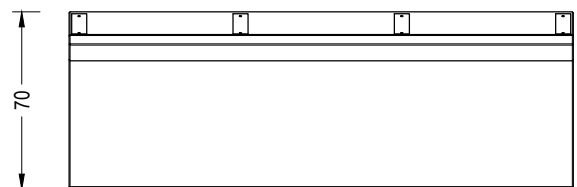

POSTERIOR  
 BACK VIEW