

CARACTERÍSTICAS / CHARACTERISTICS

MATERIAL polietileno HDPE
COLOR carta de colores estándar
ACABADO micro-texturado
COLOC. apoyado sin anclaje
 anclado con tornillos
PESO 40kg
ILUMINACIÓN 3 perfiles led, 43w
 color blanco t°5000k

MATERIAL polyethylene HDPE
COLOUR standard colour chart
FINISH micro-textured
FIXING free-standing
 fixed with screws
WEIGHT 40kg
LIGHTING 3 led strips, 43w
 white t°5000k

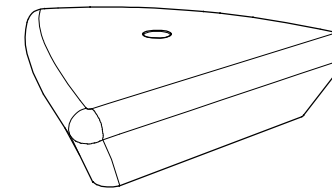

Update 10/03/2022
 Cotas / Sizes cm

INSTALACIÓN / INSTALLATION

E:1/40

1. INDOOR sin anclaje / free standing

2. OUTDOOR anclado / anchored

- ① tapa registro roscada
threaded inspection hatch
- ② acometida eléctrica
service lead
- ③ tornillo M6
screw M6
- ④ fijador lateral M5
side fastener M5
- ⑤ casquillo para pavimento M6
threaded bushing pavement M6

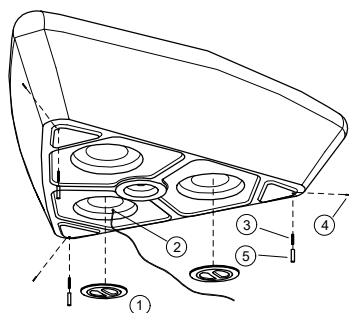
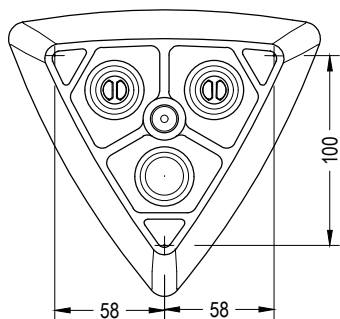

Oculto y Removable.

Roscar tornillo M6 a casquillo suministrado. Posicionar conjunto de casquillo + tornillo en orificios preexistentes en el banco. Atornillar 3 fijadores laterales M5 hasta presionar el tornillo M6. Girar banco, marcar posicionamiento. Taladrar el pavimento (Ø20), llenar con resina o mortero rico y colocar banco.
Hidden and Removable. Screw the M6 screws into the bushing supplied. Place the bushing+screw kit in the existing holes in the bench. Screw in 3 M5 side fasteners until the M6 screw is tight. Rotate the bench, mark the position. Drill holes in pavement (Ø20), fill with resin or fat mortar and place the bench.

Opcionalmente, para incrementar el peso, el cliente puede lastrarlo con arena.
 Optionally, to gain weight, the customer can ballast it with sand.

GEOMETRÍA / GEOMETRY

E:1/20

EXTASI PLASTIC

