

CARACTERÍSTICAS / CHARACTERISTICS

MATERIAL madera tropical certificada FSC®
ACABADO tratado con aceite translúcido
SOPORTES acero zincado / acero inoxidable
ACABADO pintado plata texturizado / -
COLOC. anclado con tacos de expansión
PESO banco 44kg / silla 20kg
 banca 22kg / asiento 9kg

MATERIAL tropical wood FSC® certified
FINISH treated with translucent oil
SUPPORTS zinc plated steel / stainless steel
FINISH textured silver coated / -
FIXING anchored with expansion bolts
WEIGHT bench 44kg / chair 20kg
 backless bench 28kg / seat 9kg

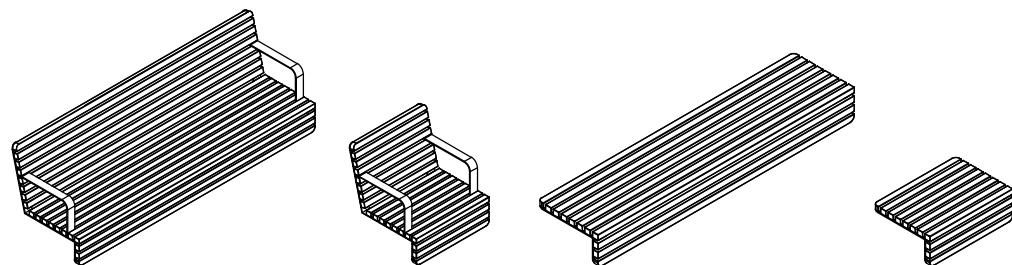

Update 05/07/2022
 Cotas / Sizes cm

INSTALACIÓN / INSTALLATION

Centrar y colocar el accesorio sobre el banco o muro y marcar agujeros colisos
 Center and place the accessory on the bench or retaining wall and mark the slotted holes

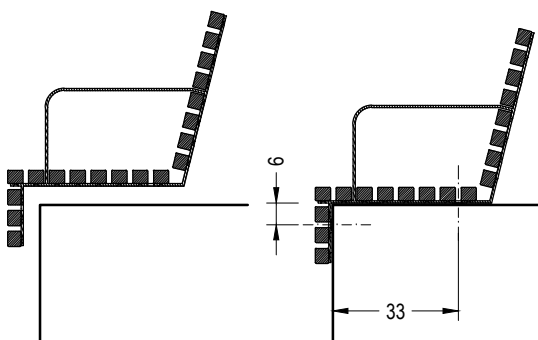

E:1/20

Taladrar el banco o muro y situar el accesorio
 Drill bench or retaining wall and place the accessory

Insertar y roscar los 4 o 6 tacos de expansión 8 x 45mm
 Insert and tightly 4 or 6 expansion bolts 8 x 45mm

Incorpora arandelas de nylon para separar la madera del soporte
 Includes nylon washers to separate the wood from the support



E:1/40

GEOMETRÍA / GEOMETRY

A. UNIVERSE banco / bench

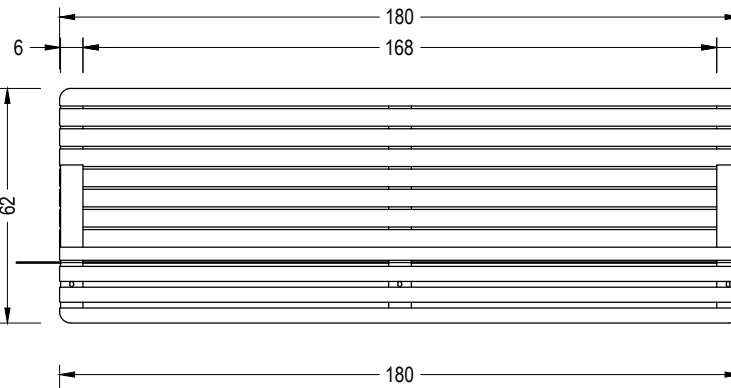

B. UNIVERSE silla / chair

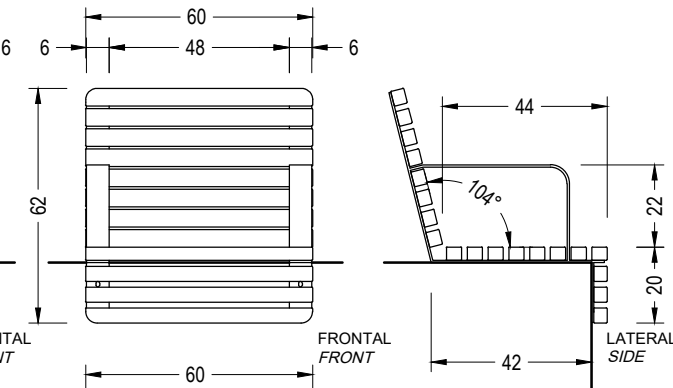

E:1/20

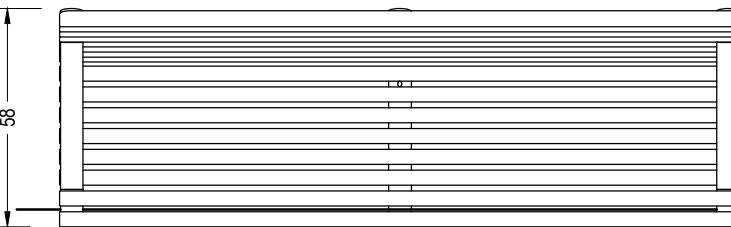

C. UNIVERSE banca / backless bench

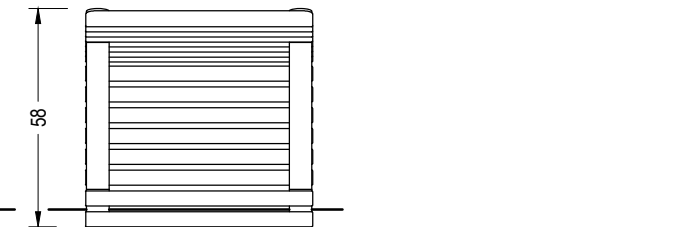

D. UNIVERSE asiento / seat

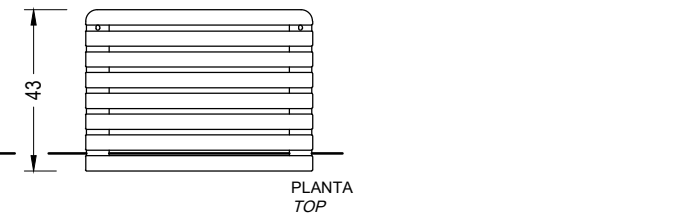
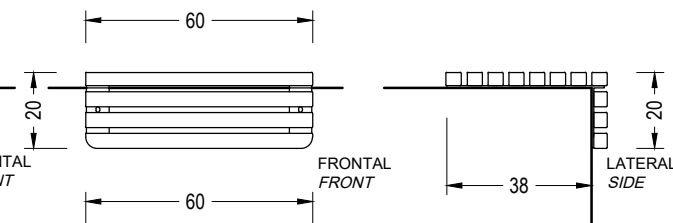
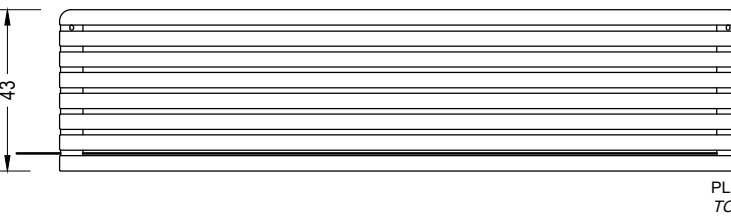
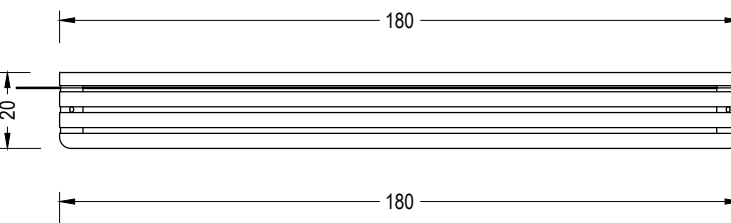

SOCRATES + UNIVERSE

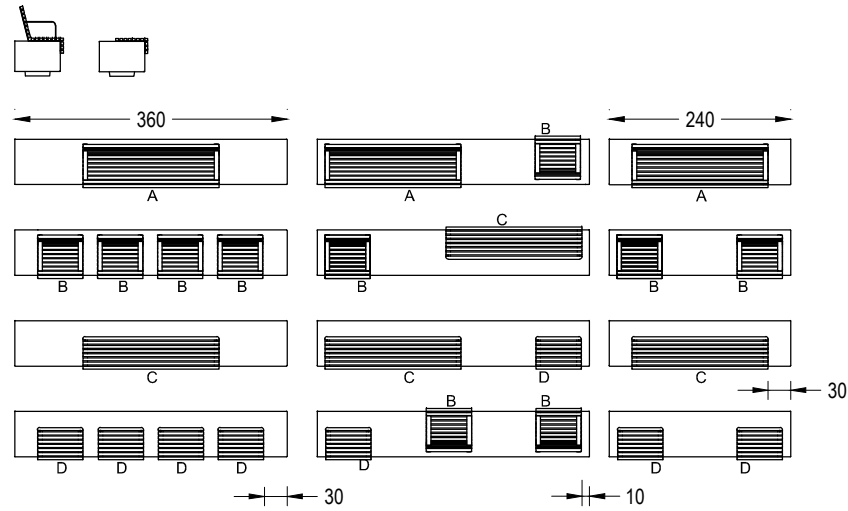

BOX + UNIVERSE

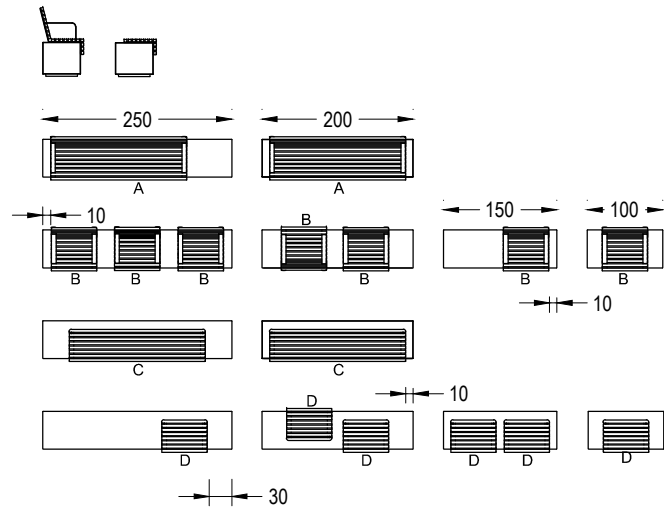

GARONNE + UNIVERSE

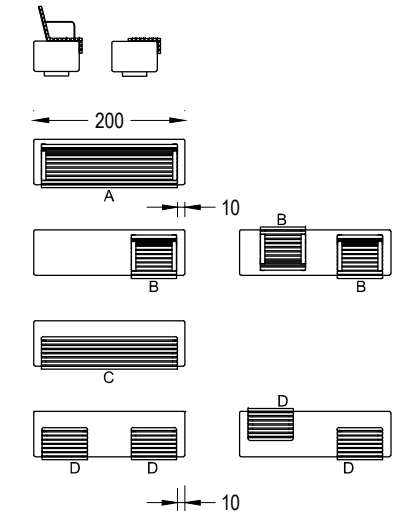

LONGO + UNIVERSE

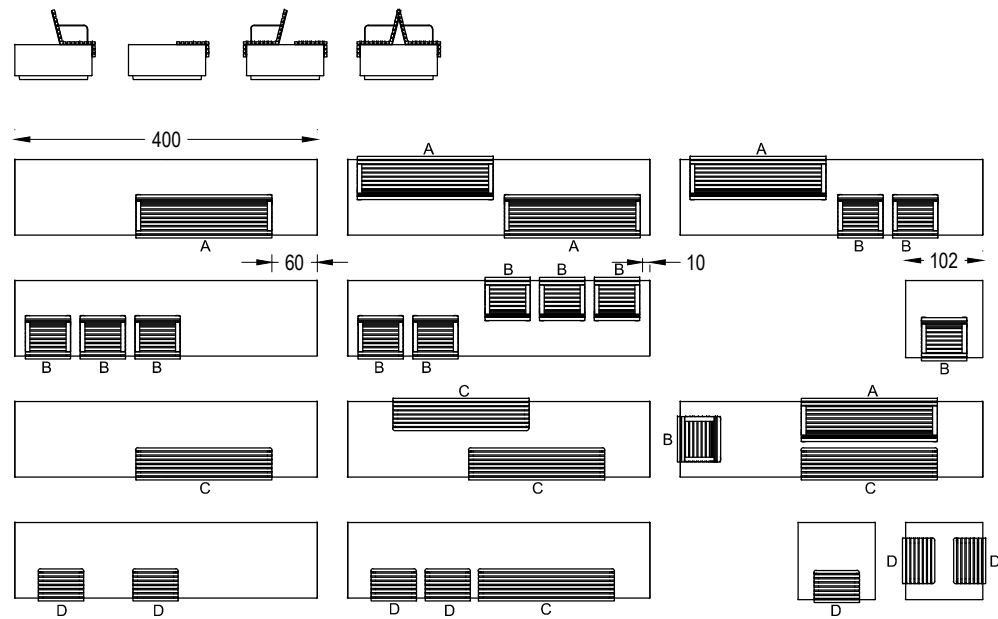

GODOT + UNIVERSE

