

CARACTERÍSTICAS / CHARACTERISTICS

MATERIAL madera tropical certificada FSC®
 madera pino certificada FSC®
ACABADO tratada con aceite translúcido
 tratada al autoclave y protección fungicida
SOPORTE acero zincado
ACABADO pintado carta de colores estándar
COLOC. anclado con tornillos
PESO banco 220: 77 kg (apoyarazos: 83 kg)
 banco 150: 66 kg (apoyarazos: 72 kg)
 silla: 48 kg (apoyabrazos: 54 kg)

MATERIAL tropical wood FSC® certified
 pine wood FSC® certified
FINISH treated with translucent oil / high-pressure
 protected and preventive fungicide
SUPPORT zinc plated steel
FINISH standard colour chart coated finish
FIXING anchored with screws
WEIGHT bench 220: 77 kg (armrest: 83 kg)
 bench 150: 66 kg (armrest: 72 kg)
 chair: 48 kg (armrest: 54 kg)

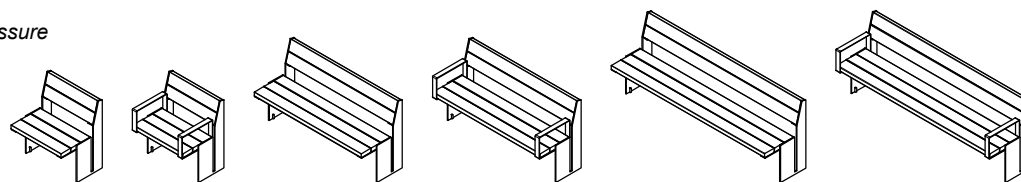

Update 23/09/2022
 Cotas / Sizes cm

INSTALACIÓN / INSTALLATION

elevación / hoisting
 P = 77 kg / 83 kg / 48 kg / 54 kg

eslingas de poliéster /
 polyester slings

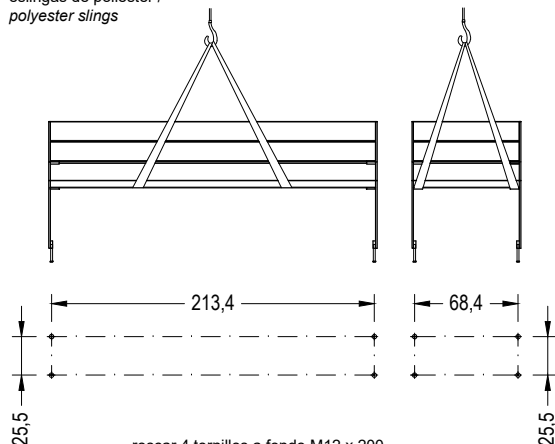

rosacar 4 tornillos a fondo M12 x 200
 tightly screw 4 stud bolts M12 x 200

taladrar el pavimento Ø30 mm y llenar con resina
 drill pavement Ø30 mm and fill with resin

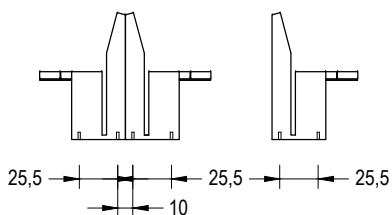

AGREGACIÓN / AGGREGATION



GEOMETRÍA / GEOMETRY

E:1/50

MOOK 220 banco / bench

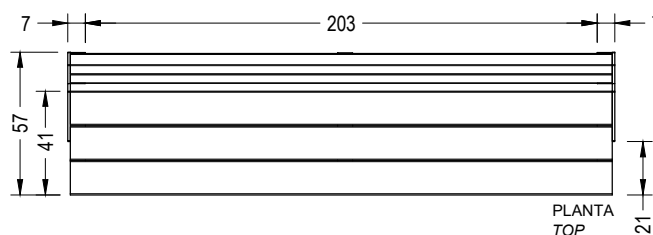
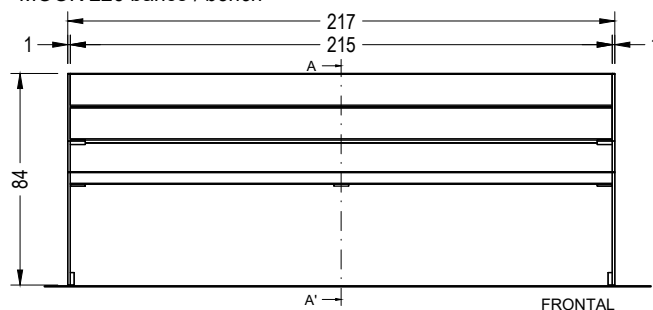

MOOK silla / chair

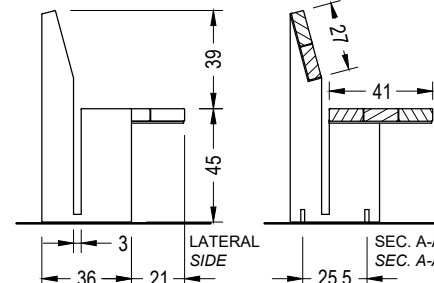
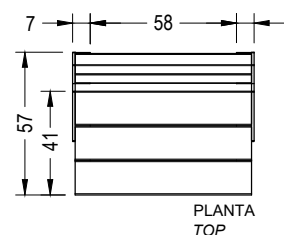
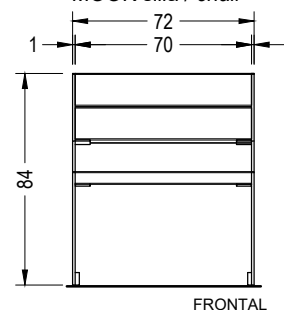

E:1/30

MOOK 220 banco apoyabrazos / armrest bench

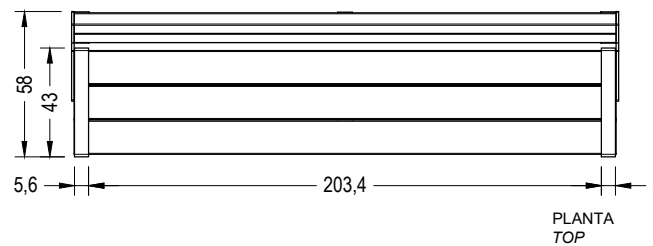
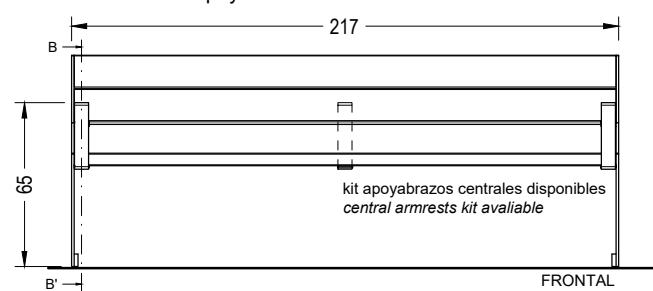

MOOK silla apoyabrazos / armrest chair

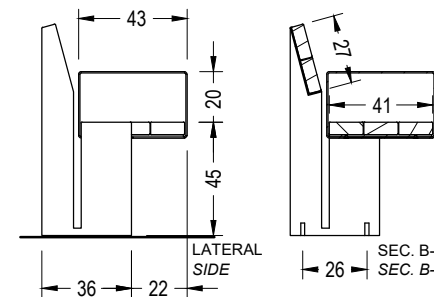
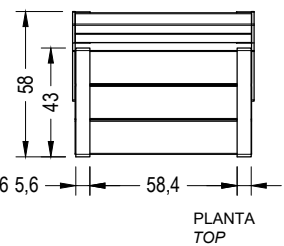
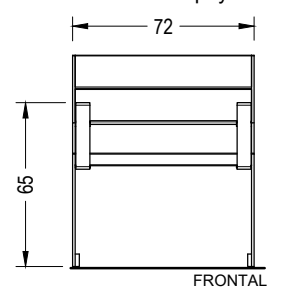

CARACTERÍSTICAS / CHARACTERISTICS

MATERIAL madera tropical certificada FSC®
 madera pino certificada FSC®
ACABADO tratada con aceite translúcido
 tratada al autoclave y protección fungicida
SOPORTE acero zincado
ACABADO pintado carta de colores estándar
COLOC. anclado con tornillos
PESO banco 220: 77 kg (apoyarazos: 83 kg)
 banco 150: 66 kg (apoyarazos: 72 kg)
 silla: 48 kg (apoyabrazos: 54 kg)

MATERIAL tropical wood FSC® certified
 pine wood FSC® certified
FINISH treated with translucent oil / high-pressure
 protected and preventive fungicide
SUPPORT zinc plated steel
FINISH standard colour chart coated finish
FIXING anchored with screws
WEIGHT bench 220: 77 kg (armrest: 83 kg)
 bench 150: 66 kg (armrest: 72 kg)
 chair: 48 kg (armrest: 54 kg)

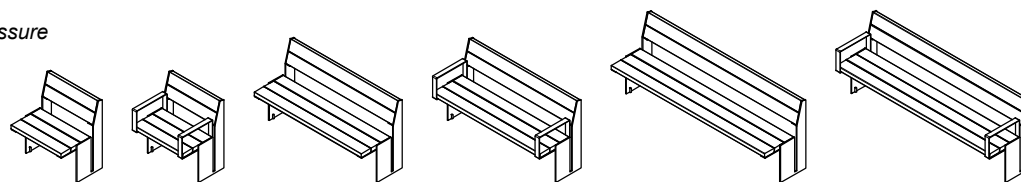

Update 23/09/2022
 Cotas / Sizes cm

INSTALACIÓN / INSTALLATION

elevación / hoisting
 P = 66 kg / 72 kg

eslingas de poliéster /
 polyester slings

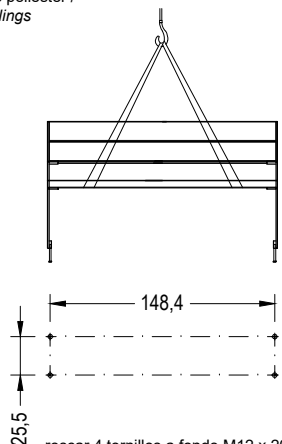

roscar 4 tornillos a fondo M12 x 200
 tightly screw 4 stud bolts M12 x 200

taladrar el pavimento Ø30 mm y llenar con resina
 drill pavement Ø30 mm and fill with resin

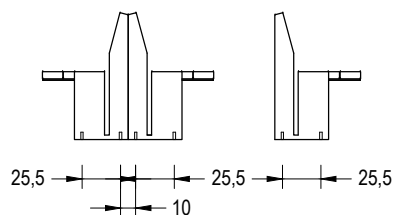

AGREGACIÓN / AGGREGATION

E:1/100



GEOMETRÍA / GEOMETRY

E:1/30

MOOK 150 banco / bench

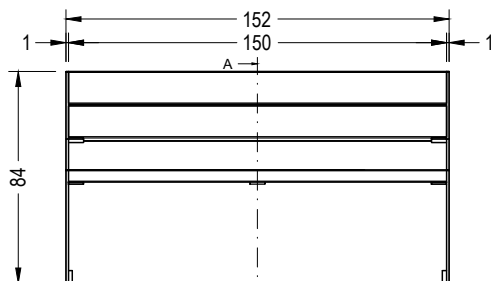

FRONTAL
 FRONT

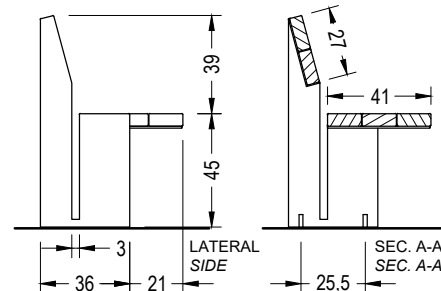

LATERAL
 SIDE

SEC. A-A'
 SEC. A-A'

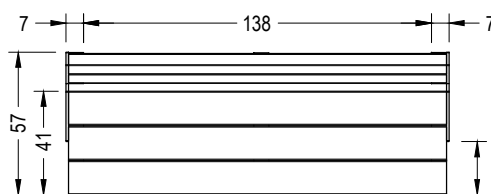

PLANTA
 TOP

MOOK 150 banco apoyabrazos / armrest bench

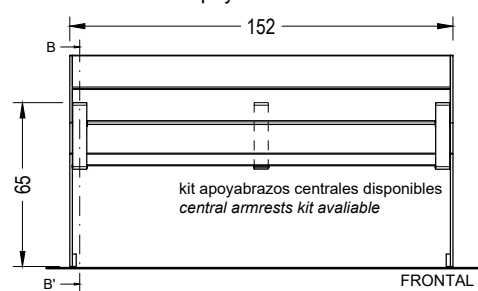

FRONTAL
 FRONT

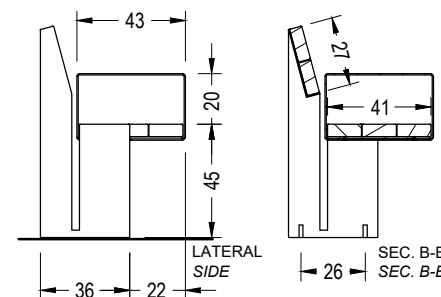

LATERAL
 SIDE

SEC. B-B'
 SEC. B-B'

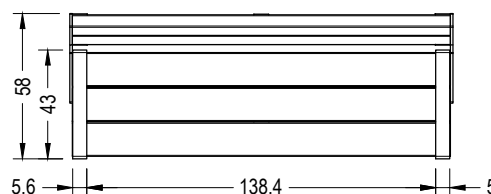

PLANTA
 TOP

CARACTERÍSTICAS / CHARACTERISTICS

MATERIAL madera tropical certificada FSC®
 madera pino certificada FSC®
ACABADO tratada con aceite translúcido
 tratada al autoclave y protección fungicida
SOPORTE acero zincado
ACABADO pintado carta de colores estándar
COLOC. anclado con tornillos
PESO taburete: 35 kg / banca: 55 kg
 mesa: 90 kg

MATERIAL tropical wood FSC® certified
 pine wood FSC® certified
FINISH treated with translucent oil
 high-pressure protected and preventive fungicide
SUPPORT zinc plated steel
FINISH standard colour chart coated finish
FIXING anchored with screws
WEIGHT stool: 35 kg / backless bench: 55 kg
 table: 90 kg

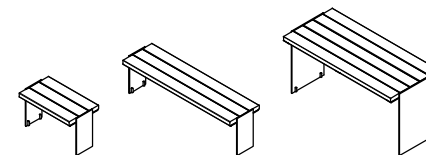

Update 23/09/2022
 Cotas / Sizes cm

INSTALACIÓN / INSTALLATION

elevación / hoisting
 P = 35 kg / 55 kg / 48 kg / 54 kg

eslingas de poliéster /
 polyester slings

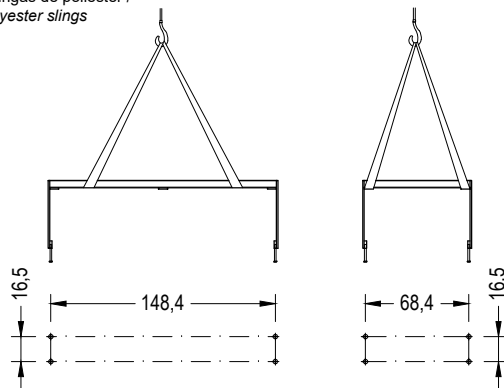

E:1/50

roskar 4 tornillos a
 fondo M12 x 200
 tightly screw 4 stud
 bolts M12 x 200

taladrar el pavimento
 Ø30 mm y llenar con
 resina
 drill pavement Ø30 mm
 and fill with resin

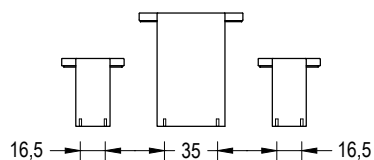
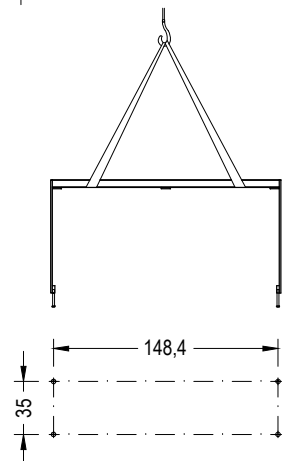

GEOMETRÍA / GEOMETRY

MOOK banca / backless bench

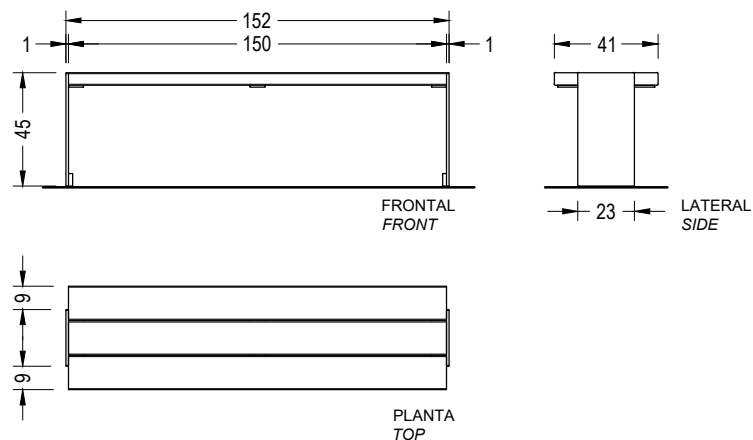

MOOK tamburete / stool

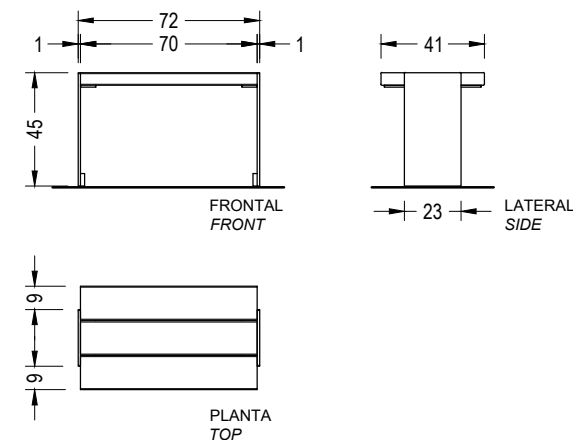

E:1/30

MOOK mesa / table

