

CARACTERÍSTICAS / CHARACTERISTICS

MATERIAL	polietileno HDPE	MATERIAL	polyethylene HDPE
COLOR	carta de colores estándar	COLOUR	standard colour chart
ACABADO	micro-texturado	FINISH	micro-textured
COLOC.	anclado / apoyado sin anclaje	FIXING	anchored / free-standing
PESO	12 kg	WEIGHT	12 kg

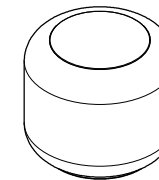

Update 19/01/2024
Cotas / Sizes cm

INSTALACIÓN / INSTALLATION

E:1/30

1. INDOOR

sin anclaje / free standing

2. OUTDOOR

anclado / anchored

- ① tapa registro roscada
threaded inspection hatch
- ② tornillo M6
screw M6
- ③ fijador lateral M5
side fastener M5
- ④ casquillo para pavimento M6
threaded bushing for pavement M6

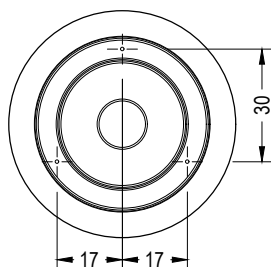
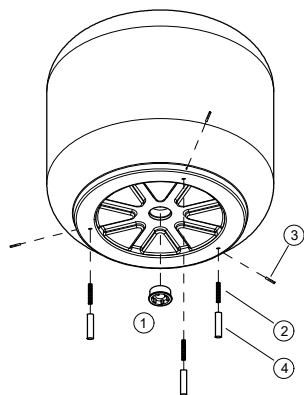

Oculto y Removible. Roscar tornillo M6 a casquillo suministrado. Posicionar conjunto de casquillo+tornillo en orificios preexistentes en el banco. Atornillar 3 fijadores laterales M5 hasta presionar el tornillo M6. Girar banco, marcar posicionamiento. Taladrar el pavimento (Ø20), llenar con resina o mortero rico y colocar banco.

Hidden and Removable. Screw the M6 screws into the bushing supplied. Place the bushing+screw kit in the existing holes in the bench. Screw in 3 M5 side fasteners until the M6 screw is tight. Rotate the bench, mark the position. Drill holes in pavement (Ø20), fill with resin or fat mortar and place the bench.

Opcionalmente, para incrementar el peso, el cliente puede lastrarlo con arena.
Optionally, to gain weight, the customer can ballast it with sand.

GEOMETRÍA / GEOMETRY

E:1/30

STUL

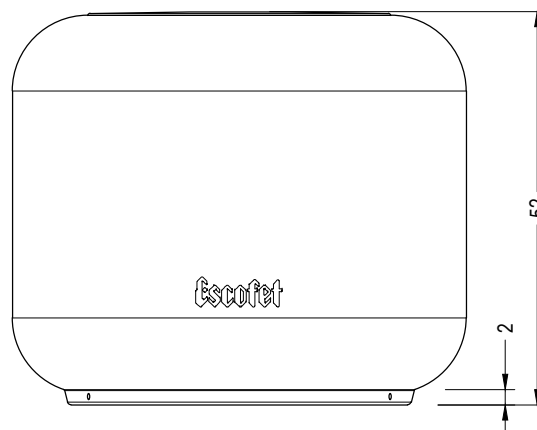

FRONTAL
FRONT

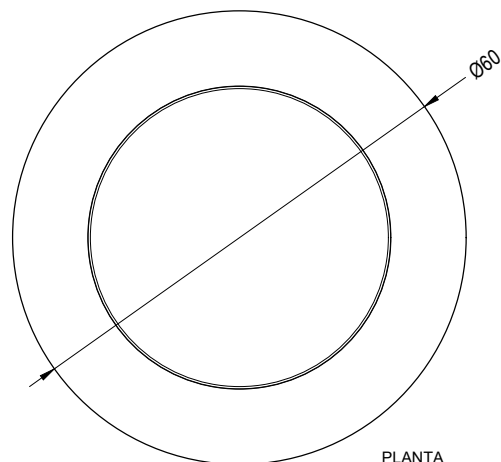

PLANTA
TOP

E:1/150

