

# CARACTERÍSTICAS / CHARACTERISTICS

MATERIAL	Hormigón/ Hormigón reciclado	MATERIAL	Concrete/ Recycled concrete
COLOR	carta de colores estándar	COLOUR	standard colour chart
ACABADO	decapado	FINISH	etched
COLOC.	anclado con tornillos	FIXING	anchored with screws
PESO	342kg	WEIGHT	342kg

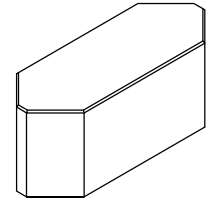

Update 22/09/2025  
Cotas / Sizes cm

## INSTALACIÓN / INSTALLATION

E:1/40

elevación / hoisting  
P = 342kg  
eslingas de poliéster  
polyester slings

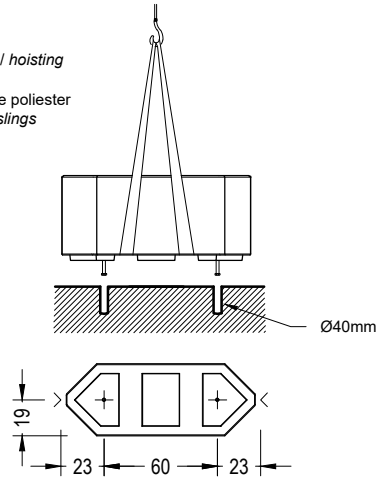

roscar 2 tornillos a fondo (Din 931 M16 x 140 mm) /  
tightly screw stud bolts (Din 931 M16 x 140 mm)

taladrar el pavimento y llenar con resina o mortero rico /  
drill pavement and fill with resin or fat mortar

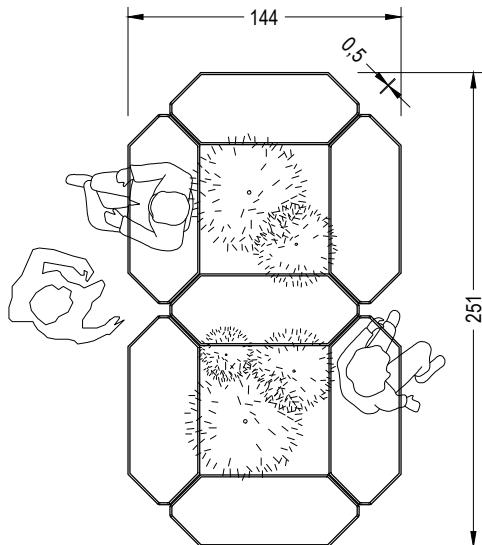

## GEOMETRÍA / GEOMETRY

E:1/16

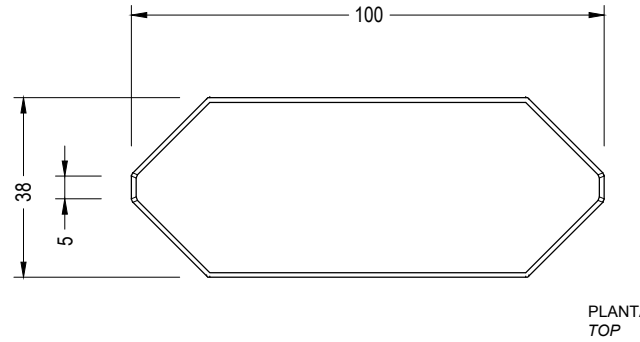
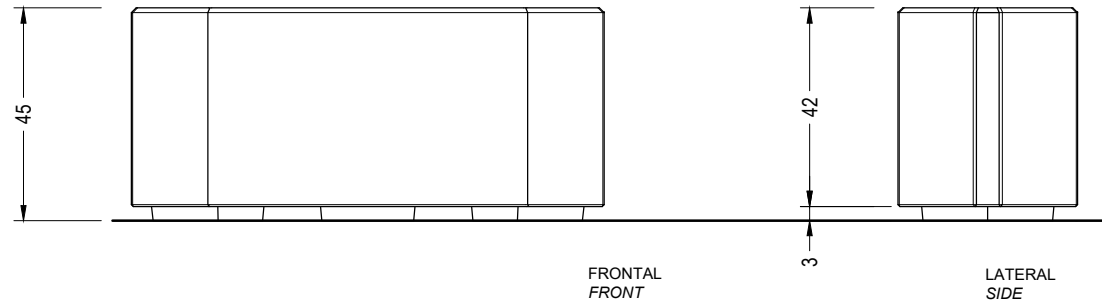

ABECEDARIO / ALPHABET

E:1/150

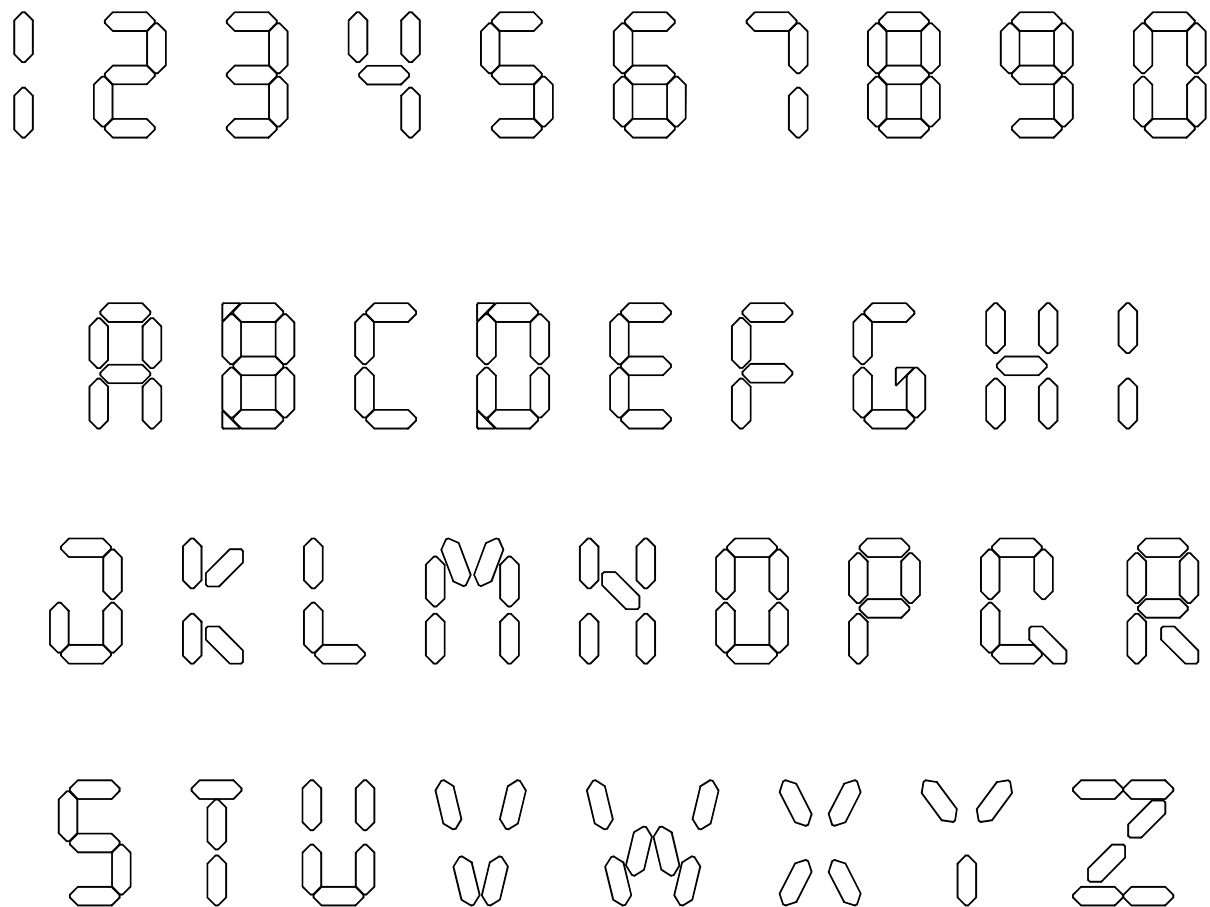

CARACTERES ESPECIALES / SPECIAL CHARACTERS

E:1/200

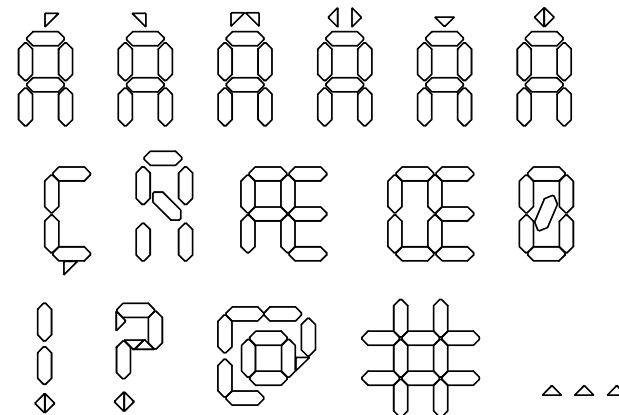

AGREGACIONES/ AGGREGATIONS

E:1/250

