





DIGITAL

DIGITAL is an urban furniture solution designed to incorporate words, numbers and symbols into public space, transforming each intervention into an element of communication and collective identity. Based on a modular concrete system, it enables flexible compositions that function as wayfinding, communication and placemaking elements, integrating naturally into urban, landscape and architectural projects.

Concrete |  100 cm/max. |  342 kg |  2

 Update 16.06.2026

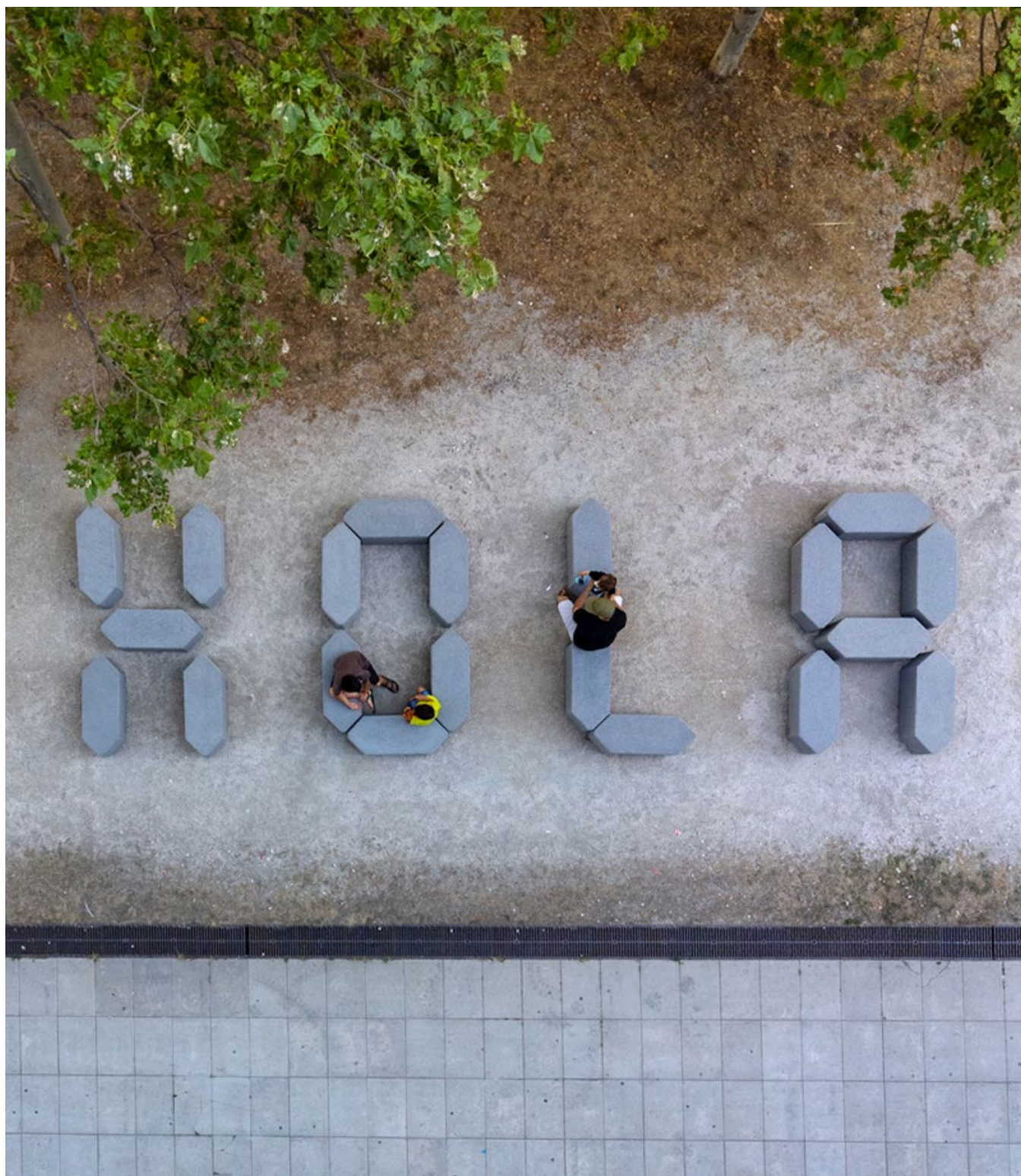

Pau Casaldàliga

Escofet
by Molins[®]

ORIGIN

Public space is not only experienced, it is also interpreted. DIGITAL stems from the ambition to integrate language into architecture and urban furniture, allowing words, numbers and symbols to become part of the spatial experience while contributing to identity, orientation and meaning.

DESIGN

DIGITAL is based on the universal geometry of the 7-segment module, reinterpreted as an urban furniture element. The combination of its components makes it possible to create numbers, letters and symbols that can be adapted to different spatial contexts and uses. Its modular character encourages the creation of urban landmarks, wayfinding systems and site-specific interventions, naturally integrated into urban and landscape projects.

MATERIAL

Molded concrete with sandblasted finish, with the option of recycled aggregate. In grey-coloured models, Eco-Grey® technology enables the integration of aggregates obtained from recycled concrete while maintaining the material's characteristic performance and appearance.

INSTALLATION

Installation is carried out using conventional lifting and handling systems. All modules are fixed to the pavement by means of two threaded bolts anchored to embedded sleeves integrated into the base of each element, ensuring stability and accurate positioning.



DIGITAL



1. Digital

Digital

Dimensions 100 x 38 x 45 cm

Weight 342 kg

1.1 General characteristics

Material	Concrete Recycled concrete	Installation	Anchored with screws
-----------------	-------------------------------	---------------------	----------------------

Finish	Etched and waterproofed
---------------	-------------------------

Colors



GR. Grey

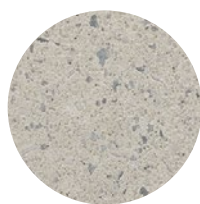

BL. White



CA. Grey CA

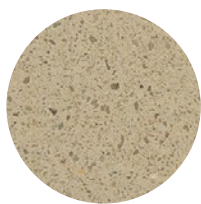

BG. Beige

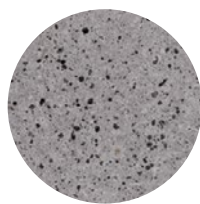

EGR. Eco-Grey

1.2 Installation

Lifting

P= 342 kg

Installation

Screw in 2 bolts fully (DIN 931 M16 x 140 mm).
Drill the pavement and fill with resin or rich mortar.

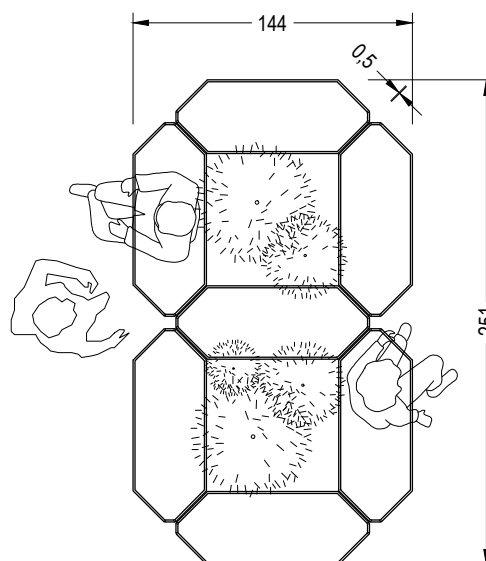
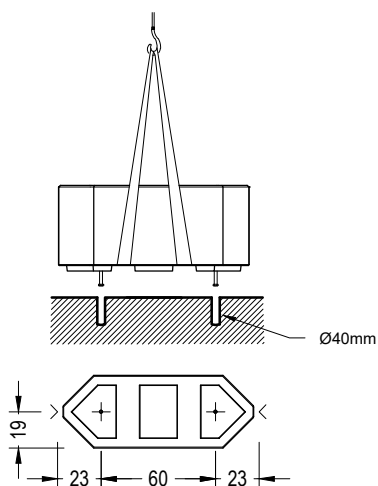

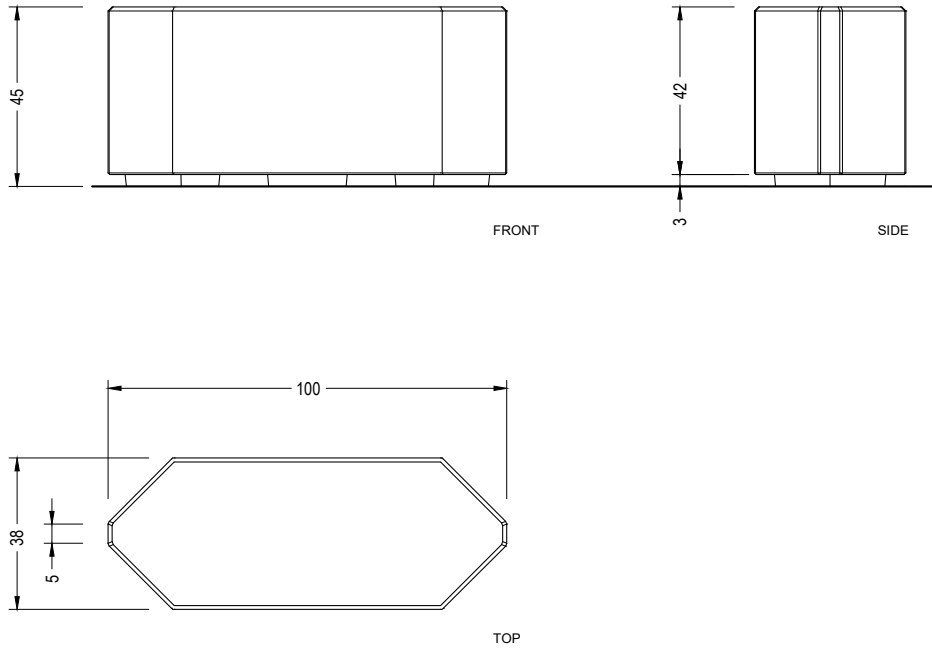

Alphabet

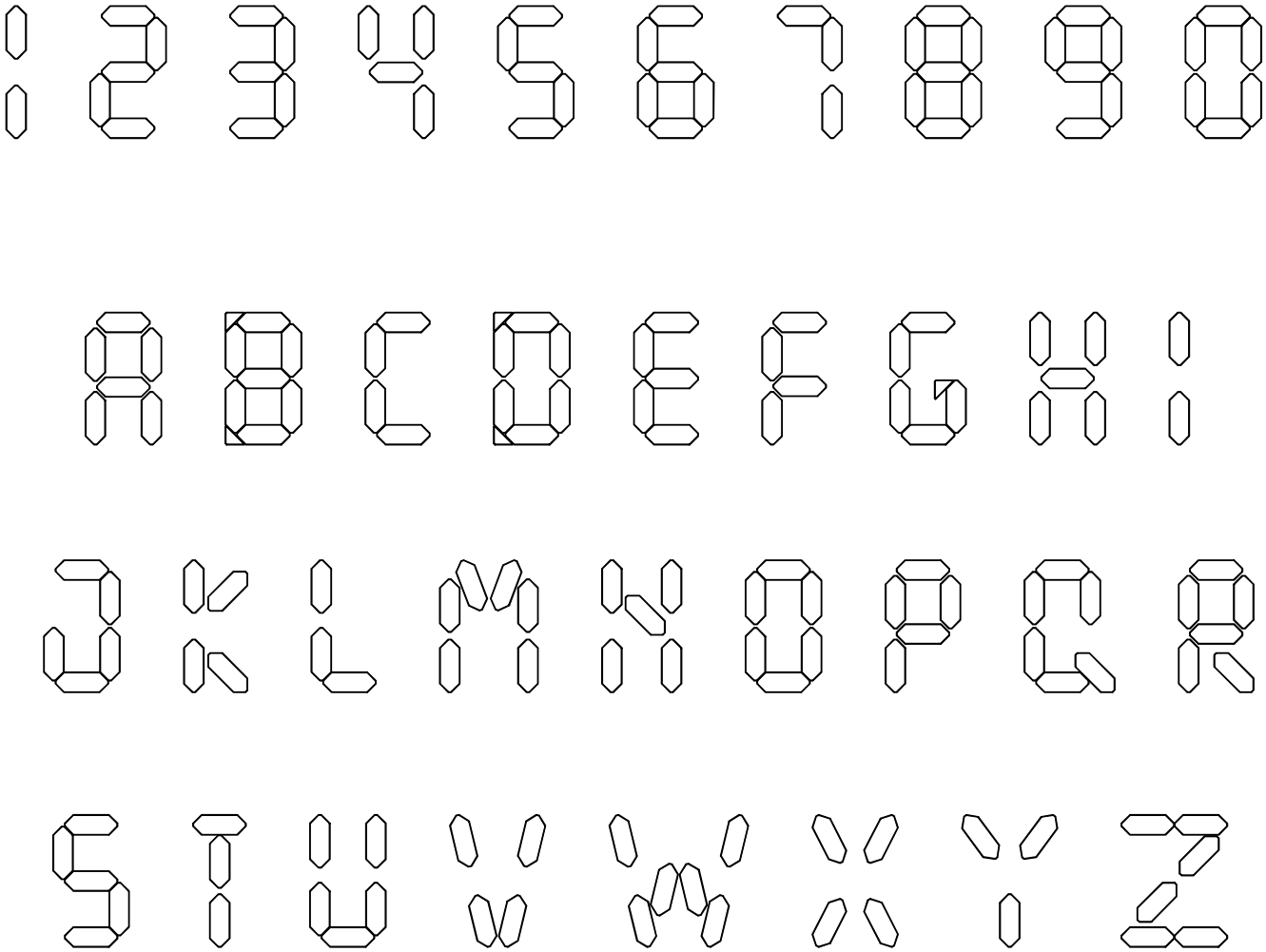

Special characters

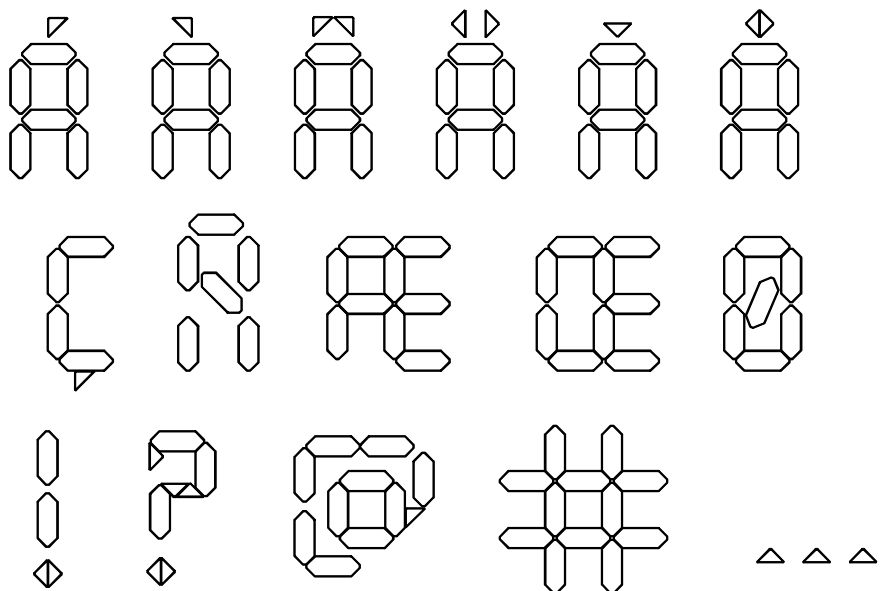

Aggregations

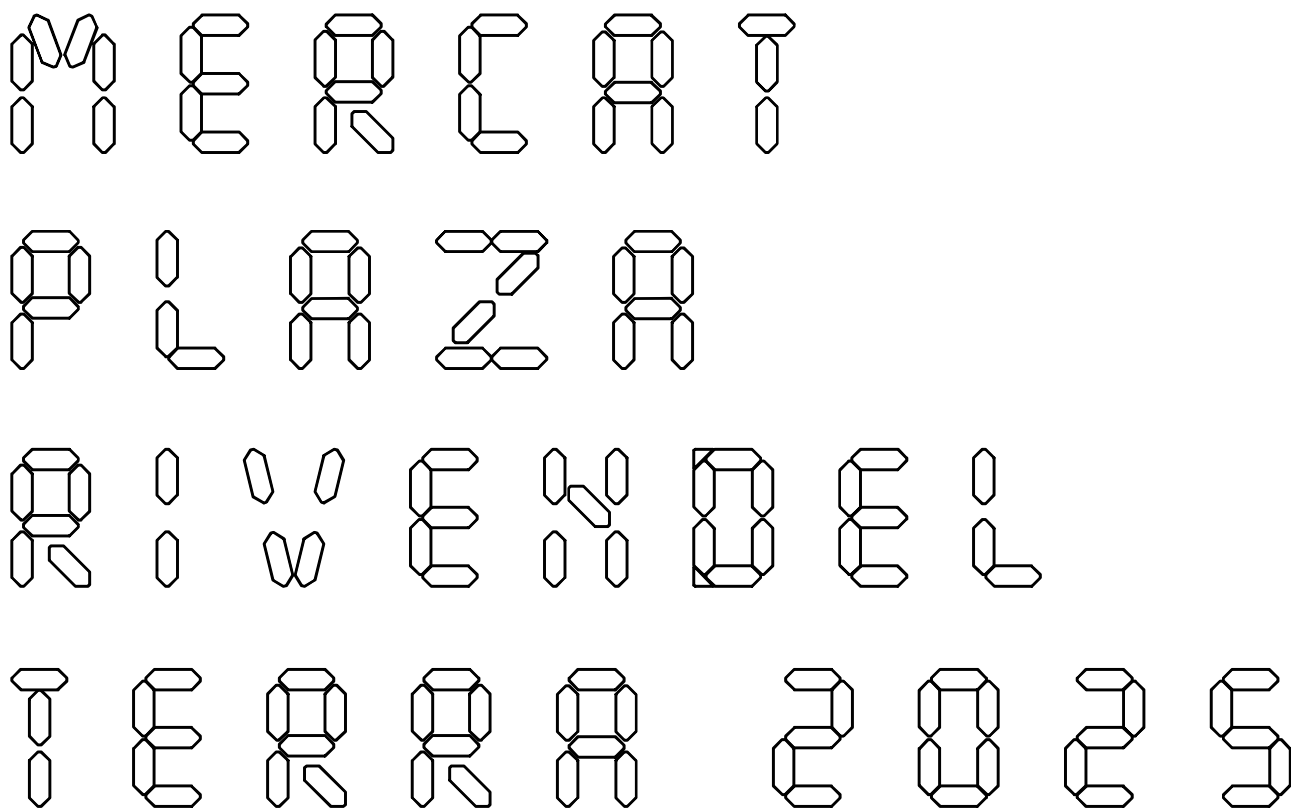

DIGITAL

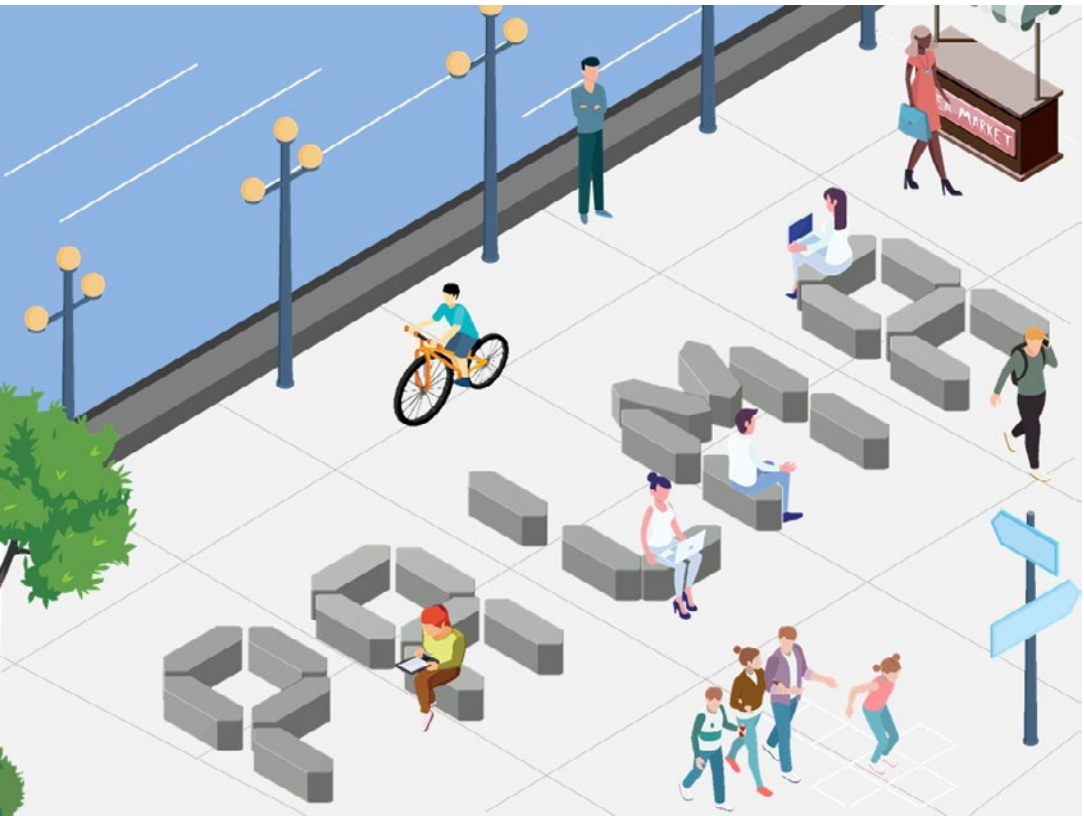



WARRANTY

5-year warranty on concrete elements.

The names, trademarks, and industrial designs of the products have been registered accordingly. The technical information provided by Escofet about its products may be subject to change without prior notice.

Escofet 1886 S.A
Head office and production

Montserrat, 162
E 08760 Martorell
Barcelona - España
T. 0034 937 737 150
F. 0034 937 737 151

info@escofet.com
www.escofet.com

Escofet
by Molins[®]



GA-2005/0072



SST-0090/2010



ER-0403/2016

